

Keysight N2002A Noise Source Test Set

Notice: This document contains references to Agilent. Please note that Agilent's Test and Measurement business has become Keysight Technologies. For more information, go to www.keysight.com.

User's Guide

Notice

Information contained in this document is subject to change without notice. Agilent Technologies makes no warranty of any kind with regard to this material, including, but not limited to, the implied warranties of merchantability and fitness for a particular purpose. Agilent Technologies shall not be liable for errors contained herein or for incidental or consequential damages in connection with the furnishings, performance, or use of this material. No part of this document may be photocopied, reproduced, or translated to another language without the prior written consent of Agilent Technologies.

Certification

Agilent Technologies certifies that this product met its published specifications at the time of shipment from the factory. Agilent Technologies further certifies that its calibration measurements are traceable to the United States National Institute of Standards and Technology, to the extent allowed by the Institute's calibration facility, and to the calibration facilities of other International Standards Organization members.

Manufacturing Part Number: N2002-90003

Print Date: September 2014

© Copyright 2012-2014 Keysight Technologies

Warranty

This Agilent Technologies instrument product is warranted against defects in material and workmanship for a period of one year from date of shipment. During the warranty period, Agilent Technologies will at its option, either repair or replace products which prove to be defective. For warranty service or repair, this product must be returned to a service facility designated by Agilent Technologies. Buyer shall prepay shipping charges to Agilent Technologies and Agilent Technologies shall pay shipping charges, duties, and taxes for products returned to Agilent Technologies from another country. Agilent Technologies warrants that its software and firmware designated by Agilent Technologies for use with an instrument will execute its programming instructions when properly installed on that instrument. Agilent Technologies does not warrant that the operation of the instrument, or firmware will be uninterrupted or error free.

Limitation of Warranty

The foregoing warranty shall not apply to defects resulting from improper or inadequate maintenance by Buyer, Buyer-supplied software or interfacing, unauthorized modification or misuse, operation outside of the environmental specifications for the product, or improper site preparation or maintenance.

NO OTHER WARRANTY IS EXPRESSED OR IMPLIED. AGILENT TECHNOLOGIES SPECIFICALLY DISCLAIMS THE IMPLIED WARRANTIES OF MERCHANTABILITY AND FITNESS FOR A PARTICULAR PURPOSE.

Exclusive Remedies

THE REMEDIES PROVIDED HEREIN ARE BUYER'S SOLE AND EXCLUSIVE REMEDIES. AGILENT TECHNOLOGIES SHALL NOT BE LIABLE FOR ANY DIRECT, INDIRECT, SPECIAL, INCIDENTAL, OR CONSEQUENTIAL DAMAGES, WHETHER BASED ON CONTRACT, TORT, OR ANY OTHER LEGAL THEORY.

Safety Notices

This guide uses warnings and cautions to denote hazards.

WARNING

***Warning* denotes a hazard. It calls attention to a procedure which, if not correctly performed or adhered to, could result in injury or loss of life. Do not proceed beyond a warning note until the indicated conditions are fully understood and met.**

CAUTION

Caution denotes a hazard. It calls attention to a procedure that, if not correctly performed or adhered to, could result in damage to or destruction of the instrument. Do not proceed beyond a caution sign until the indicated conditions are fully understood and met.

NOTE

Note calls out special information for the user's attention. It provides operational information or additional instructions of which the user should be aware.

General Safety Information

This instrument has been designed and tested in accordance with IEC Publication 61010-1+A1+A2:1992 Safety requirements for Electrical Equipment for Measurement, Control and Laboratory Use and has been supplied in a safe condition.

The instruction documentation contains information and warnings which must be followed by the user to ensure safe operation and to maintain the instrument in a safe condition.

WARNING

No operator serviceable parts inside, refer servicing to service trained personnel.

WARNING

If this instrument is not used as specified, the protection provided by the equipment could be impaired. This instrument must be used in a normal condition (in which all means of protection are intact only).

CAUTION

This instrument is designed for use in Installation Category I and Pollution Degree 2 as per IEC 61010 and 60664 respectively.





NOTE

This product does not contain an operator replaceable fuse. Disregard the marking referring to the '~ Line Fuse'. This is not a mains operated unit.

Safety Symbols

The following symbols on the instrument and in the manual indicate precautions which must be taken to maintain safe operation of the instrument.

Table 1 Safety Symbols

	<p>The Instruction Documentation Symbol. The product is marked with this symbol when it is necessary for the user to refer to the instructions in the supplied documentation.</p>
	<p>This symbol indicates that a device, or part of a device, may be susceptible to electrostatic discharges (ESD) which can result in damage to the product. Observe ESD precautions given on the product, or its user documentation, when handling equipment bearing this mark.</p>
	<p>The CE mark shows that the product complies with all relevant European Legal Directives</p>
	<p>The C-Tick mark is a registered trademark of the Australian Communications Authority. This signifies compliance with the Australian EMC Framework Regulations under the terms of the Radiocommunications Act of 1992.</p>
<p>ISM Group 1 Class A</p>	<p>This is a symbol of an Industrial, Scientific, and Medical Group 1 Class A product.</p>
<p>ICES/NMB-001</p>	<p>This ISM device complies with Canadian ICES-001. Cet appareil ISM est conforme a la norme NMB-001 du Canada.</p>
	<p>South Korean Class A EMC Declaration A 급 기기 (업무용 방송통신기자재) 이 기기는 업무용 (A 급) 전자파적합기기로서 판매자 또는 사용자는 이 점을 주의하시기 바라 며 , 가정외의 지역에서 사용하는 것을 목적으로 합니다. This equipment is Class A suitable for professional use and is for use in electromagnetic environments outside of the home.</p>

Where to Find the Latest Information

Documentation is updated periodically. For the latest information about Agilent Noise Source Test Set, please visit the following Internet URL:

<http://www.agilent.com/find/nsts/>

Declaration of Conformity

A copy of the Manufacturer's European Declaration of Conformity for this instrument can be found at the following website:

<http://regulations.about.keysight.com/DoC/search.htm>

Table of Contents

	Page
1. Using the N2002A	
Introduction	2
Recommended Test Equipment	2
Description	5
Operation	6
Maintenance	7
N2002A Verification Test	7
General Specifications	9
Replaceable Parts	10
Service	12
Returning a Noise Source Test Set for Repair	12
2. The Noise Source Calibration Process and Recommended Test Equipment	
The Calibration Process	14
Calibration Cycle	15
Test Descriptions	16
Excess Noise Ratio (ENR dB)	16
Reflection Coefficient Magnitude and Phase	19
Reference Standard Noise Source Selection	22
Recommended Test Equipment	23
3. Using the Manual Calibration Procedure	
Introduction	26
Before You Start	26
Recording the Test Results	26
Failure During the Test Procedures	26
ENR Manual Procedure	27
The Equations.	31
System Uncertainty Values	32
Reflection Coefficient Manual Procedure	34
Calibrating the 8753	34
Measuring the DUT over 1st Frequency Range	37
Calibrating the 8722	40
Measuring the DUT over 1st Frequency Range	43

4. Manually Programming Data into an Agilent Smart Noise Source	
Introduction	48
Equipment Required	48
Data Programming Process	49
Formatting the Data	49
Editing the Data File	50
Programming the Data File into the SNS	51
Example	52
5. Using the Agilent N2002A Noise Source Demonstration Software	
Getting Started	54
Additional Software Requirements	54
System Requirements	55
Test Equipment	55
Directory Structure Required	56
Opening the VEE Pro 6.0 (.vee) Software File	56
Setting up the Address Drivers	57
Configuring the VEE Pro 6.0 Run Time File IO	58
Before running the Agilent N2002A Noise Source Demonstration Software	59
The ENR Measurement Procedure	60
Running the Agilent N2002A Noise Source Demonstration Software	62
Test Details	65
ENR Measurement	67
Selecting and Measuring the Reference Standard	69
Selecting the Reference Standard	71
Entering Reference Standard Uncertainty Data	73
Selecting Reference Standard Measurement Uncertainty Data	76
Performing Reference Standard Measurement	77
Selecting the DUT to be Measured	78
Selecting the DUT	80
Measuring a DUT	82
Copying Data to SNS	85
Making Multi Measurement on a DUT	87
Selecting Other	90
Setting SNS Bias Current	93
A. Test Records for the 346A	
Reflection Coefficient Magnitude and Phase Test Record	96
Excess Noise Ratio (ENR) Test Record	98
Uncertainty Test Record	99

B. Test Records for the 346B	
Reflection Coefficient Magnitude and Phase Test Record.	102
Excess Noise Ratio (ENR) Test Record.	104
Uncertainty Test Record	105
C. Test Records for the 346C	
Reflection Coefficient Magnitude and Phase Test Record.	108
Excess Noise Ratio (ENR) Test Record.	110
Uncertainty Test Record	112
D. Test Records for the N4000A	
Reflection Coefficient Magnitude and Phase Test Record.	116
Excess Noise Ratio (ENR) Test Record.	118
Uncertainty Test Record	119
E. Test Records for the N4001A	
Reflection Coefficient Magnitude and Phase Test Record.	122
Excess Noise Ratio (ENR) Test Record.	124
Uncertainty Test Record	125
F. Test Records for the N4002A	
Reflection Coefficient Magnitude and Phase Test Record.	128
Excess Noise Ratio (ENR) Test Record.	130
Uncertainty Test Record	132

G. Caring for Connectors

Introduction	136
Connector Part Numbers	136
Handling and Storage	136
Visual Inspection	137
Obvious Defects and Damage	137
Mating Plane Surfaces	137
Precision 7 mm Connectors.	138
Sexed Connectors	139
Cleaning	141
Compressed Air	141
Cleaning Alcohol	141
Precision 7 mm Connectors.	142
Cleaning Interior Surfaces	143
Drying Connectors.	144
Mechanical Inspection: Connector Gages	145
Mechanical Specifications	146
Precision 7mm Connectors	146
Sexed Connectors	147
50 Ohm Type-N Connectors	147
75 Ohm Type-N Connectors	148
Using Connector Gages	149
Inspecting and Cleaning the Gage	149
Zeroing the Gage	149
Making Connections.	152
Align Connectors Carefully.	152
To Make a Preliminary Connection	153
Final Connection Using a Torque Wrench.	154
Disconnection.	155
Adapters	157
Principles of Microwave Connector Care	159

1 Using the N2002A

This chapter contains specifications and typicals for the Agilent N2002A noise source test set. The distinction between specification and typicals is described as follows.

Specifications describe the performance of parameters covered by the product warranty. (The temperature range is 0° C to 55° C, unless otherwise noted.)

Typical performance describes additional product performance information that is not covered by the product warranty. It is performance beyond specification that 80% of the units exhibit with a 95% confidence level over the temperature range 20° to 30° C. Typical performance does not include measurement uncertainty.

Introduction

This manual contains operating information for the Agilent N2002A Noise Source Test Set. It is needed when making Excess Noise Ratio (ENR) tests on a noise source. The N2002A Noise Source Test Set operates over a frequency range of 10.0 MHz to 26.5 GHz.

Figure 1-1

The N2002A Noise Source Test Set

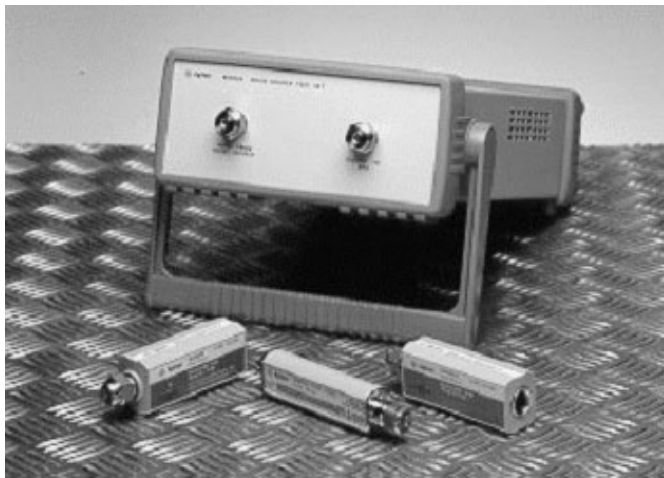

The Agilent N2002A Noise Source Test Set is controlled by a 11713A Attenuator/Switch Driver. The 11713A can be controlled using the supplied *Agilent N2002A Noise Source Demonstration Software* or it can be controlled manually. These control methods are described in separate chapters.

Recommended Test Equipment

Table 2-4 and Table 2-5 lists the recommended test equipment for the excess noise ratio (ENR) measurement and the reflection coefficient magnitude and phase calibration respectively.

Limited substitution of test equipment is supported when using the *Agilent N2002A Noise Source Demonstration Software*.

The noise source calibration process needs adapters and cables. The cables and adapters are available as an option (Option 001) with the Agilent N2002A. Agilent Technologies recommends using high quality cables and precision adapters. You must ensure all cables and adapters are specified for the frequency range they are operating in. You also need to ensure that they are in good electrical and mechanical condition.

For assistance in choosing the appropriate cable/adaptor, or if you are not sure about the correct selection of cables and adapters please contact your local Agilent sales office.

NOTE

System performance is only guaranteed if each instrument in the test system/process is within the manufacturer's recommended calibration period.

CAUTION

Ensure the correct torque settings are used at all times. Refer to Table G-2 on page 155.

Before You Start

Switch the test equipment on and let it warm up for at least one hour. Allow the Noise Sources to stabilize at the ambient room temperature. Do not use a noise source for one hour prior to performing the tests.

Read the rest of this section before you start any of the tests.

Recording the Test Results

If you are doing the measurements manually, ensure you make a copy of the Test Record of the model you are measuring. Test Records are provided in the Appendices for each noise source model.

Agilent Technologies recommend that you make a copy of the Test Record, recording the test results on the copy, and keep the copy for your calibration test record. This record could prove valuable in tracking gradual changes in test results over long periods of time.

Introduction

Failure During the Test Procedures

If the ENR tests fail and you suspect the N2002A or the DUT requires repair. Please contact your local Agilent Customer Sales and Service Office for replacement parts or repair service information. Refer to “Service” on page 12 for your local Sales and Service Offices.

Handling Precautions

Proper connector care is essential. See Appendix G , “Caring for Connectors,” on page 135 for more information.

CAUTION

Do not rotate the Noise Source body when connecting it to the Noise Source Test Set, or internal damage may result.

CAUTION

Do not drop the noise source. Dropping can damage the unit.

Description

Figure 1-2 shows the Noise Source Test Set with the cover removed. Figure 1-3 shows the internal wiring and the reference designators of the parts used in the Noise Source Test Set.

Figure 1-2 The Noise Source Test Set with Outer Cover Removed



Figure 1-3 The Noise Source Test Set Schematic Component Layout

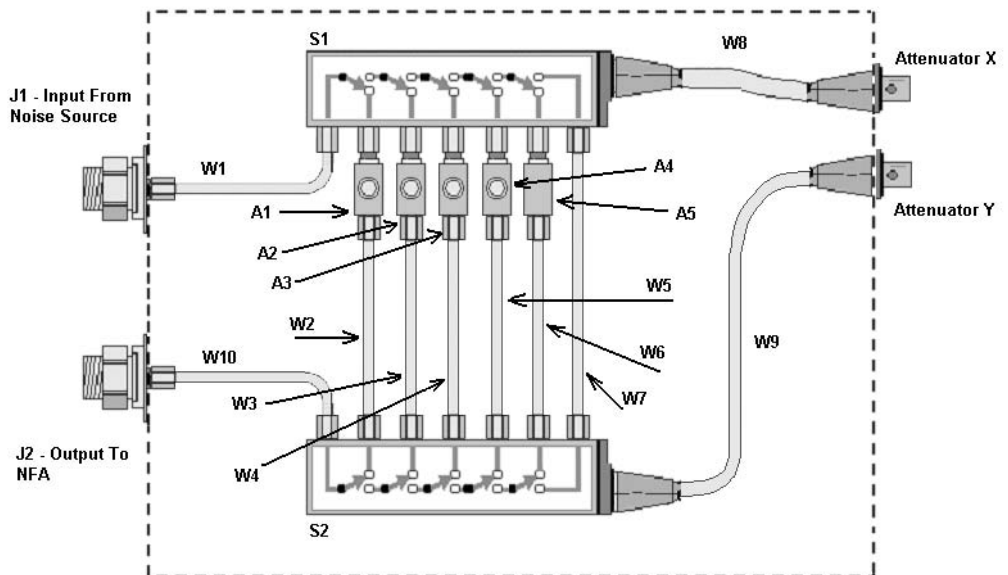

Operation

This section refers to control operation of the Agilent N2002A Noise Source Test Set. The Noise Source Test Set is controlled by a 11713A attenuator/switch driver. The 11713A switch controlling settings are shown in the Table 1-1. For more detailed operating instructions, refer to the *Agilent 11713A Attenuator/Switch Driver Operating and Service Manual (Part number 11713-90023)*.

NOTE

Connect the X and Y Drive cables between the rear panels of the Noise Source Test Set and the 11713A Attenuator/Switch Driver.

Table 1-1 **11713A Attenuator/Switch Driver Settings**

Frequency Path (MHz)	Attenuator X				Attenuator Y				Switches	
	1	2	3	4	5	6	7	8	9	0
10 to <3000									X	X
3000 to 6000	X				X					
<6000 to 12000			X				X			
>12000 to 18000		X				X				
>18000 to 26500				X				X		

Maintenance

Proper connector care is a vital part of the maintenance which should be performed by the user. The life of the connector can be greatly extended by following the general connector care practices outlined in Appendix G , “Caring for Connectors,” on page 135.

N2002A Verification Test

The verification test procedure involves confirming that the N2002A Noise Source Test Set’s switch paths are functioning and the VSWR meets its typical limit. Table 1-2 lists the typical VSWR limit and the switch positions on the 11713A.

Equipment Required

- Network analyzer frequency coverage from 10MHz to 26.5GHz.
- Appropriate network analyzer calibration kits.
- Agilent 11713A Attenuator / Switch Driver.
- Viking cables for connection to 11713A.

Connections Required

Connect the Viking control cables from the rear of the 11713A attenuator/switch driver to the rear of the N2002A Noise Source Test Set. Connect Atten X on the 11713A to Attenuator X on the N2002A and Atten Y on the 11713A to Attenuator Y on the N2002A.

Table 1-2 **Typical VSWR**

Frequency	Typical VSWR Limit	Switch Positions
10 MHz	1:1.05	0 On, 9 On
100 MHz	1:1.05	0 On, 9 On
1 GHz	1:1.05	0 On, 9 On
2 GHz	1:1.05	0 On, 9 On
3 GHz	1:1.05	0 On, 9 On
4 GHz	1:1.1	1 On, 5 On

Table 1-2 **Typical VSWR**

Frequency	Typical VSWR Limit	Switch Positions
5 GHz	1:1.1	1 On, 5 On
6 GHz	1:1.1	1 On, 5 On
7 GHz	1:1.15	3 On, 7 On
8 GHz	1:1.15	3 On, 7 On
9 GHz	1:1.15	3 On, 7 On
10 GHz	1:1.15	3 On, 7 On
11 GHz	1:1.15	3 On, 7 On
12 GHz	1:1.15	3 On, 7 On
13 GHz	1:1.15	2 On, 6 On
14 GHz	1:1.15	2 On, 6 On
15 GHz	1:1.15	2 On, 6 On
15 GHz	1:1.15	2 On, 6 On
17 GHz	1:1.15	2 On, 6 On
18 GHz	1:1.15	2 On, 6 On
19 GHz	1:1.18	4 On, 8 On
20 GHz	1:1.18	4 On, 8 On
21 GHz	1:1.18	4 On, 8 On
22 GHz	1:1.18	4 On, 8 On
23 GHz	1:1.18	4 On, 8 On
24 GHz	1:1.18	4 On, 8 On
25 GHz	1:1.18	4 On, 8 On
26 GHz	1:1.18	4 On, 8 On
26.5 GHz	1:1.18	4 On, 8 On

General Specifications

NOTE This instrument is designed for indoor use only.

Table 1-3 Physical Dimension Specifications

Height	88.5 mm (3.5 inches)
Width	212.6 mm (8.5 inches)
Depth	348.3 mm (13.7 inches)
Weight	3.36 kg

Temperature Range Operating: 0° C to +55° C

Storage: -40° C to +70° C

Humidity Range Operating: Up to 95% relative humidity to 40°C (non-condensing)

Altitude Range Operating: To 4,600 meters

Replaceable Parts

Table 1-4 and Table 1-5 lists the replaceable parts available for the Agilent N2002A Noise Sources Test Set.

Table 1-4 **Replaceable Parts**

Reference	Quantity	Description	Part Number
A1	1	18GHz - 26.5GHz Isolator	N2002-80001
A2	1	12GHz - 18GHz Isolator	N2002-80002
A3	1	6GHz - 12GHz Isolator	N2002-80003
A4	1	3GHz - 6GHz Isolator	N2002-80004
A5	1	3dB Attenuator	8493C
J1, J2	2	Bulkhead Connector	5062-1247
S1, S2	2	Multi-port Switch	8769K
W1	1	Semi rigid cable	N2002-62003
W2, W3	2	Semi rigid cable	N2002-62007
W4	1	Semi rigid cable	N2002-62006
W5	1	Semi rigid cable	N2002-62005
W6	1	Semi rigid cable	N2002-62008
W7	1	Semi rigid cable	N2002-62002
W8, W9	2	Viking cable	N2002-62001
W10	1	Semi rigid cable	N2002-62004

To order parts contact your local Agilent Technologies Sales and Service Office. Refer to “Service” on page 12 for your local Sales and Service Offices

Table 1-5

Mechanical Assemblies

Description	Quantity	Part Number
Front Frame	1	N2002-20001
EMI Screen	1	N2002-20002
Front Panel	1	N2002-00003
Chassis	1	N2002-00005
Base plate	1	N2002-00002
Switch Support	1	N2002-00001
Rear Panel	1	N2002-00004
Rear Bezel	1	E4418-20008
Cover	1	E4418-61027
Front Bumper	1	34401-86011
Rear Bumper	1	34401-86012
Handle	1	34401-45011

Service**Returning a Noise Source Test Set for Repair**

When returning a Noise Source Test Set to Agilent Technologies for repair send it to your nearest Sales and Service Office. These are listed in Table 1-6.

Table 1-6 Agilent Technologies Sales and Service Offices

UNITED STATES	Agilent Technologies (tel) 1 800 452 4844
CANADA	Agilent Technologies Canada Inc. Test & Measurement (tel) 1 877 894 4414
EUROPE	Agilent Technologies Test & Measurement European Marketing Organization (tel) (31 20) 547 2000
JAPAN	Agilent Technologies Japan Ltd. (tel) (81) 426 56 7832 (fax) (81) 426 56 7840
LATIN AMERICA	Agilent Technologies Latin America Region Headquarters, USA (tel) (305) 267 4245 (fax) (305) 267 4286
AUSTRALIA/NEW ZEALAND	Agilent Technologies Australia Pty Ltd. (tel) 1-800 629 4852 (Australia) (fax) (61 3) 9272 0749 (Australia) (tel) 0-800 738 378 (New Zealand) (fax) (64 4) 802 6881 (New Zealand)
ASIA PACIFIC	Agilent Technologies, Hong Kong (tel) (852) 3197 7777 (fax) (852) 2506 9284

2

**The Noise Source Calibration
Process and Recommended Test
Equipment**

The Calibration Process

The calibration process consists of two performance verification tests:

- Excess Noise Ratio (ENR dB) test.
- Reflection Coefficient Magnitude and Phase tests.

The performance verification test procedures verify the electrical performance to traceable standards of the following Agilent noise sources in accordance with their published specification.

- 346A
- 346B
- 346C
- N4000A
- N4001A
- N4002A

NOTE

The noise source calibration process also allows you to calibrate both Agilent Technologies and other manufacturer's noise sources operating between 10.0 MHz and 26.5 GHz.

NOTE

All tests are performed without access to the interior of the noise source.

NOTE

The noise source calibration process also allows you to calibrate additional measurement frequency points other than the standard cardinal points. The measurement frequency points are determined by the frequency entries in the ENR table.

The maximum measurement frequency/ENR pairs is 81.

Calibration Cycle

The noise sources require periodic verification of operational performance. Under normal use and environmental conditions, a noise source is calibrated at 12 month intervals.

Test Descriptions

Excess Noise Ratio (ENR dB)

The Excess Noise Ratio (ENR) test is based on comparing the DUT test results to a reference standard test results. The reference standard is a calibrated noise source with known ENR values. Measurements are taken on both the reference standard and the DUT. The DUT ENR values are derived from these results.

These results verify that the noise source meets its published specification. The specifications are provided in Table 2-1.

The measurements are generally made at the cardinal frequencies points, however, the NFA can allow up to 81 frequency/ENR pairs to be stored. The supplied test records in the appendices only contain the cardinal frequency points, therefore you need to create test record to increase this quantity.

NOTE

The test should be performed within an environmental ambient temperature of $296 \pm 1\text{K}$ ($23^\circ \pm 1^\circ\text{C}$).

Loading the Reference Standard's ENR Data

1. If you are using an SNS as a Reference Standard, the NFA uploads its ENR data automatically. The NFA needs enabled to make this happen automatically.

NOTE

Further information on loading SNS ENR data, refer to the NFA User's Guide.

2. If you are using a 346x as a Reference Standard, you can use one of the following methods:
 - The A: drive.
 - The C: drive.
 - Create a file from the data supplied with the noise source, for example, the certificate of calibration or the floppy disc.
 - If you only want to calibrate the ENR data on a 346x noise source you can use the ENR data on the noise source label.

Overview of the ENR Measurement Procedure

The process operates in the following method:

NOTE

The ENR values of the reference standard (ENR_1) are known.

1. Connect the test equipment together as shown in Figure 2-1.
2. Set the test equipment to the measure the first frequency point.
3. Measure a linear Y-Factor on the reference standard.
4. On the Test Record note the result under the (Y_1) column.
5. Set the test equipment to the measure the next frequency point and repeat the process until all the measurement points are complete.
6. Remove the reference standard from the N2002A input and connect the DUT.
7. Set the test equipment to the measure the first frequency point.
8. Measure linear Y-Factor on the DUT.
9. On the Test Record note the result under the (Y_2) column.
10. Repeat this process for the remaining measurement points.
11. Using these measurement results, entering them in the equations, calculate the ENR and the uncertainty values.

The Noise Source Calibration Process and Recommended Test Equipment
Test Descriptions

The Test Equipment Connection Diagrams for ENR Measurements

Figure 2-1 ENR Measurements

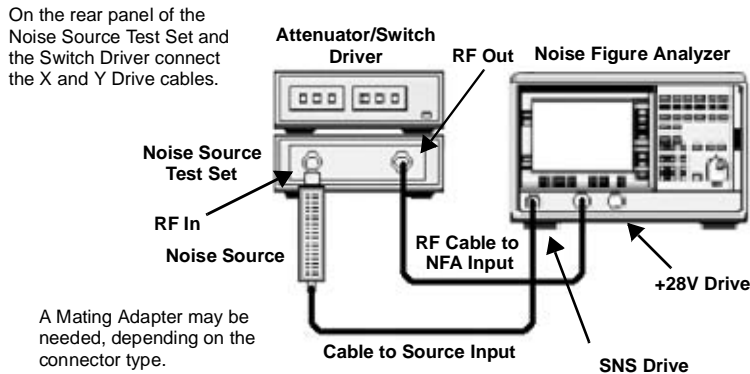

ENR Specifications

NOTE Specifications are valid at ambient temperature 23° Celsius only (296 K).

Table 2-1 ENR Range for the Noise Sources

Instrument model	ENR Range
N4000A/346A	4.5 - 6.5 dB
N4001A/346B	14 - 16 dB
N4002A/346C	12 - 17 dB

Reflection Coefficient Magnitude and Phase

The Reflection Coefficient test measures the input magnitude and phase of the noise source under test and verifies that it meets its published specification. The specifications are provided in Table 2-2 and Table 2-3. The tests are measured in the Source ON and OFF states.

The specified frequency ranges are swept for the maximum magnitude and phase and the resultant maximum value is displayed on the VNA. The test also measures the magnitude and phase at cardinal (pre-determined) frequency points. These cardinal frequency points depend on the model and option being tested.

The test equipment is connected together as shown in Figure 2-2.

Overview of the Reflection Coefficient Magnitude and Phase Measurement Procedure

NOTE

The procedure requires network analyzer frequency range coverage from 10.0 MHz to 26.5 GHz. This procedure uses two VNAs, the 8753 is used to cover the range 10.0 MHz to 3.0 GHz, and the 8722 is used to cover the range 3.0 GHz to 26.5 GHz.

The procedure operates in the following method:

1. Calibrate the 8753 over the specified range, for example, 10.0 MHz to 1.5 GHz.
2. Measure the DUT's reflection coefficient, in an OFF and ON state, over the specified range, for example, 10.0 MHz to 1.5 GHz.
3. Note these resultant values on the Test Record.
4. Measure the DUT's reflection coefficient, in an OFF and ON state, at the cardinal frequency points in the specified range.
5. Note these resultant values on the Test Record.
6. Repeat the Calibration and Measurement process using the 8753 over the specified range, for example, 1.5 GHz to 3.0 GHz.
7. Calibrate the 8722 over the specified range, for example, from 3.0 GHz to 7.0 GHz.

The Noise Source Calibration Process and Recommended Test Equipment Test Descriptions

8. Measure the DUT's reflection coefficient, in an OFF and ON state, over the specified range, for example, 3.0 GHz to 7.0 GHz.
9. Note these resultant value on the Test Record.
10. Measure the DUT's reflection coefficient, in an OFF and ON state, at the cardinal frequency points in the specified range.
11. Note these resultant values on the Test Record.
12. Repeat the Calibration and Measurement process using 8722 over the specified range, for example, 3.0 GHz to 7.0 GHz.

The Test Equipment Connection Diagrams for Reflection and Phase Measurements

Figure 2-2 Reflection and Phase Measurements

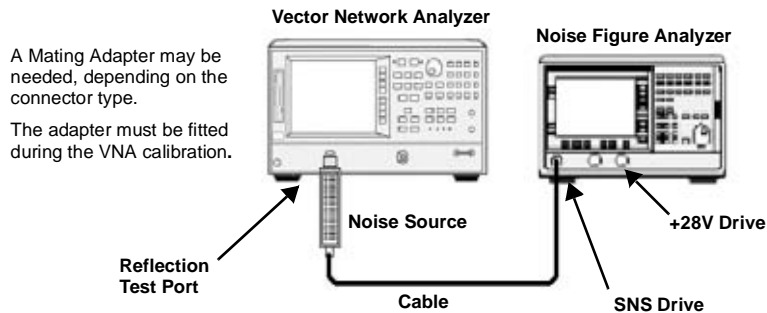

Reflection and Phase Specifications

Table 2-2 Reflection Coefficient for 346x Noise Source

Frequency Range	Model		
	346A	346B	346C
10.0 MHz to 30.0 MHz	0.13	0.13	0.11
30.0 MHz to 5.0 GHz	0.07	0.07	0.11
5.0 GHz to 18.0 GHz	0.11	0.11	0.11
18.0 GHz to 26.5 GHz	-----	-----	0.15

Table 2-3 Reflection Coefficient for the N400xA SNS

Frequency Range	Model		
	N4000A	N4001A	N4002A
10.0 MHz to 1.5 GHz	0.02	0.07	0.10
1.5 GHz to 3.0 GHz	0.02	0.07	0.10
3.0 GHz to 7.0 GHz	0.06	0.09	0.10
7.0 GHz to 18.0 GHz	0.10	0.11	0.11
18.0 GHz to 26.5 GHz	-----	-----	0.15

Reference Standard Noise Source Selection

The reference standard selection defines the measurement frequencies of both the reference standard and the DUT. Both the reference standard and the DUT must be measured at the same frequency points.

The accuracy of the DUT's ENR measurement results is dependent on the calibration accuracy of the reference standard. Also, a proportion of the DUT's measurement uncertainty is based on the reference standard's measurement uncertainty. Therefore, to maximize the measurement accuracy and minimize the measurement uncertainty, a reference standard that has been calibrated by a national standards laboratory is recommended.

NOTE

Agilent Technologies recommend the National Physical Laboratory in the United Kingdom (www.npl.co.uk) for reference standard calibration.

NOTE

A Reference Standard's ENR values are valid at calibration temperature only.

A Reference Standard's uncertainty values are only valid at ambient temperature $23^{\circ}\text{C} \pm 1^{\circ}\text{C}$ (296K).

More than one reference standard may be required for more accurate results. Agilent Technologies recommend using the same type of reference standard as the noise source being measured.

The ENR measurement process requires various adapters and cables. For more accurate results Agilent Technologies recommend using high quality cables and precision adapters. Care should be taken to ensure all cables and adapters are specified for the frequency range in which they are used and that they are in good electrical and mechanical condition.

Agilent Technologies noise sources can be used at non-standard (not cardinal) frequency points by creating an ENR table containing the wanted measurement frequency points. However, the ENR values and the ENR uncertainty values of the reference standard must be manually interpolated from the supplied data.

Recommended Test Equipment

Table 2-4 Recommended Test Equipment for ENR Measurements

Equipment Description	Critical Specifications for Equipment Substitution	Recommended Model
Noise Figure Analyzer	No substitute available for SNS	N8975A
Noise Source Test Set	No substitute available	N2002A
Attenuator/Switch Driver	Compatible with 8768K multi-port switch	11713A
Attenuator/Switch Driver Interconnect Cables (x2)	Compatible with 11713A Viking terminals	11764A
Standard Noise Source (Dependant on DUT)	See “Reference Standard Noise Source Selection” on page 22	
RF Cable	10MHz to 26.5GHz 3.5mm (M) to 3.5mm (M), 61 cm (24 in)	11500E
Adapter (NFA and Noise Source Test Set)	3.5mm Precision (F) to 3.5mm (F)	1250-1749
Adapter (Dependant on DUT)	DUT Connector Type:	Adapter Type:
	Type N (Male) 3.5mm (F) to Type N (F)	1250-1745
	Type N (Female) 3.5mm (F) to Type N (M)	1250-1744
	APC 7 3.5mm (F) to APC 7	1250-1747
	3.5mm (Male) 3.5mm (F) to 3.5mm (F)	1250-1749
BNC Lead	Length 122cm (48”), Frequency 10MHz	10503A
SNS Interconnect Cable	No substitute available	11730A

The Noise Source Calibration Process and Recommended Test Equipment
Recommended Test Equipment

Table 2-5 Recommended Test Equipment for Reflection Measurements

Equipment Description	Critical Specifications for Equipment Substitution	Recommended Model
Noise Figure Analyzer	No substitute available for the SNS	N8975A
Vector Network Analyzer 1	10MHz to 3GHz	8753ES or 8753ET, opt 004
Vector Network Analyzer 2	3GHz to 18GHz or 26.5GHz	8722ES or 8722ET, opt 004
Calibration Kit 1	Connector: Type N Impedance: 50 Ohm Bandwidth: 10MHz to 3GHz	85032E
Calibration Kit 2	Connector: 3.5mm Impedance: 50 Ohm Bandwidth: 10MHz to 3GHz	85033D
Calibration Kit 3	Connector: 7 mm Impedance: 50 Ohm Bandwidth: 10MHz to 3GHz	85031B
Calibration Kit 4	Connector: Type N Impedance: 50 Ohm Bandwidth: 10.0 MHz to 18.0 GHz	85054D
Calibration Kit 5	Connector: 3.5 mm Impedance: 50 Ohm Bandwidth: 10.0 MHz to 18.0 GHz	85052D
Calibration Kit 6	Connector: 7 mm Impedance: 50 Ohm Bandwidth: 10.0 MHz to 18.0 GHz	85050D
BNC Lead	Length 122cm (48")	10503A
SNS Interconnect Cable	No substitute available	11730A

Introduction

Before You Start

Switch the test equipment on and let it warm up for at least one hour. Allow the Noise Sources to stabilize at the ambient room temperature. Do not use a noise source for one hour prior to performing the tests.

Read the rest of this section before you start any of the tests. Make a copy of the Test Record of the models you are measuring.

Recording the Test Results

Test Records are provided in the Appendices for each Agilent noise source model.

Agilent Technologies recommend that you make a copy of the Test Record, recording the test results on the copy, and keep the copy for your calibration test record. This record could prove valuable in tracking gradual changes in test results over long periods of time.

Failure During the Test Procedures

If any of the tests fail and you suspect the unit requires repair. Please contact your local Agilent Customer Sales and Service Office for replacement parts or repair service information. Refer to “Service” on page 12 for your local Sales and Service Offices.

ENR Manual Procedure

This procedure must be performed using the Test Records.

Before you start, enter the reference standard's ENR values in the Standard ENR₁ column in the ENR Test Record and the reference standard's uncertainty values in the Standard ENR₁ Uncertainty column in the Uncertainty Test Record. These values are needed when calculating the DUT's values using the equations.

NOTE

Refer to "Reference Standard Noise Source Selection" on page 22 for information on this selection criteria.

CAUTION

Ensure the correct torque settings are used at all times. Refer to Table G-2 on page 155.

-
- Step 1.** Connect the equipment as shown in Figure 2-1. Depending on the reference standard noise source selected, connect the equipment using either the SNS interconnect cable or the BNC lead. Ensure the reference standard noise source RF connector is the same type as the DUT and connect using the preferred adapters listed in Table 2-4 on page 23.
- Step 2.** Ensure the Noise Figure Analyzer preset is set to factory settings.
1. Press the **System** key
 2. Press the **More 1 of 3** menu key.
 3. Press the **Power On/Preset** menu key.
 4. Set the Power On to **Power On (Preset)** and Preset to **Preset (Factory)**.
- Step 3.** Press **Preset** and wait for the preset routine to finish.
- Step 4.** Load the reference standard noise source ENR data.
- Refer to "Loading the Reference Standard's ENR Data" on page 16 for information on this.

NOTE

Do not calibrate the NFA. Ensure the NFA displays **Uncorr.**

Step 5. Select the display to meter mode.

1. Press the **Format** key.
2. Press the **Format** menu key.
3. Press the **Meter** menu key.

Step 6. Set the measured result to Y-Factor

1. Press the **Result** key.
2. Press the **Y-Factor** menu key.

Step 7. Set the Y-Factor scale to linear units

1. Press the **Scale** key.
2. Set the Units to **Units (Linear)**.

Step 8. Set sweep to single.

1. Press the **Sweep** key.
2. Set the Sweep to **Sweep Mode (Single)**.

Step 9. Set the frequency mode to fixed.

1. Press the **Frequency/Points** key.
2. Press the **Freq Mode** menu key.
3. Press the **Fixed** menu key.

Step 10. Set the averaging to 128 (or greater).

1. Press the **Averaging/Bandwidth** key.
2. Set the Averaging to **Averaging (On)**.
3. Set the Average Mode to **Average Mode (Sweep)**.
4. Press the **Averages** menu key and on the numeric key pad press **1, 2, 8**, followed by the **Enter** key

Step 11. Alignment point.

Step 12. Set the frequency to 10.0 MHz

1. Press the **Frequency/Points** key.
2. Press the **Fixed Freq** menu key and on the numeric key pad press **1, 0**, followed by the **MHz** menu key.

NOTE

10.0 MHz is the first frequency listed in the test record.

Step 13. Set the Attenuator/Switch Driver as follows:

1. Ensure **LOCAL LED** is on
2. Set the switch to the required frequency path, for example, switches 9 and 0 are on, when measuring between 10.0 MHz and 3.0 GHz.

NOTE

Refer to Table 1-1 for Attenuator/Switch Driver settings for other frequency ranges.

Step 14. On the NFA, press the **Restart** key, this restarts the NFA's sweep.

Step 15. When the measurement is finished, in the Test Record, enter the Y-factor reading next to the frequency point measured in the Standard Y_1 (Lin) column.

Step 16. Repeat the steps for the remaining frequencies listed in the test record.

NOTE

Set the Attenuator/Switch to the appropriate frequency path when changing between frequency ranges.

Step 17. Connect the DUT as shown in Figure 2-1. Depending on the DUT, either use the SNS interconnect cable or the BNC cable.

Using the Manual Calibration Procedure
ENR Manual Procedure

Step 18. Set the frequency to 10.0 MHz

1. Press the **Frequency/Points** key.
2. Press the **Fixed Freq** menu key and on the numeric key pad press **1, 0**, followed by the **MHz** menu key.

NOTE

10.0 MHz is the first frequency listed in the test record.

Step 19. Set the Attenuator/Switch Driver as follows:

1. Ensure **LOCAL LED** is on.
2. Set the switch to the required frequency path, for example, switches 9 and 0 are on, when measuring between 10.0 MHz and 3.0 GHz.

Step 20. On the NFA, press the **Restart** key, this restarts the NFA's sweep.

Step 21. When the measurement is finished, in the Test Record enter the Y-factor reading next to the frequency point measured in the DUT Y_2 (Lin) column.

Step 22. Repeat the steps for the remaining frequencies listed in the test record.

NOTE

Set the Attenuator/Switch to the appropriate frequency path when changing between frequency ranges.

Step 23. Using the Equation 3-1 and the results in the ENR Test Record, calculate the ENR_2 value of each fixed frequency point for the DUT. Enter the ENR_2 calculated values in the DUT ENR_2 (dB) column.

Step 24. Complete the ENR Test Record results for the DUT and ensure the measured values are within the published specification.

Step 25. Using the Equation 3-2 and the results in the Uncertainty Test Record, calculate the ENR_2 uncertainty value of each fixed frequency point for the DUT. Enter the $U_c ENR_2$ calculated value in DUT ENR_2 Uncertainty column.

Step 26. Complete the Uncertainty Test Record results for the DUT.

Step 27. If using an SNS series, transfer the data to the SNS using the procedure in the section “Data Programming Process” on page 49.

The Equations

The excess noise ratio of the DUT is calculated using the following equation at each frequency point within the table.

Equation 3-1 ENR Equation

$$ENR_2 = 10 \times \log \left[\frac{(Y_2 - 1) \times \left(T_0 \times \frac{\left(10^{\frac{ENR_1}{10}} \right)}{(Y_1 - 1)} \right)}{T_0} \right]$$

The overall expanded uncertainty is calculated using the following equation for each ENR2 value at each frequency point. Excess Noise Ratio (ENR dB) Test Records

Equation 3-2 Uncertainty Equation

$$U_C ENR_2 = \sqrt{(U_C ENR_1)^2 + (U_C Sys)^2}$$

Table 3-1 Terms Used in the Equations

Term	Description
TO	290 Kelvin
DUT	Unit Under Test
ENR ₁	Primary Standard Excess Noise Ratio value at each fixed frequency point
ENR ₂	DUT calculated Excess Noise Ratio value at each fixed frequency point
Y ₁	Primary Standard measured linear Y-Factor at each fixed frequency point
Y ₂	DUT measured linear Y-Factor at each fixed frequency point
UcENR ₁	Primary Standard expanded uncertainty for each ENR value at each fixed frequency point
UcENR ₂	DUT calculated expanded uncertainty for each ENR value at each fixed frequency point
UcSys	Overall Test system uncertainty at each fixed frequency point

System Uncertainty Values

Table 3-2 is a summary of the uncertainty analysis calculations.

Table 3-2 Uncertainty Analysis Calculation Results

Frequency (GHz)	UcSys (± dB)
0.01	0.0785
0.10	0.0785
1.00	0.0905
2.00	0.0905
3.00	0.0726
4.00	0.0726
5.00	0.0726

Table 3-2 Uncertainty Analysis Calculation Results

Frequency (GHz)	UcSys (\pm dB)
6.00	0.0726
7.00	0.0800
8.00	0.0800
9.00	0.1076
10.00	0.1076
11.00	0.1076
12.00	0.1076
13.00	0.1211
14.00	0.1211
15.00	0.1211
16.00	0.1211
17.00	0.1211
18.00	0.1211
19.00	0.1491
20.00	0.1491
21.00	0.1491
22.00	0.1491
23.00	0.1491
24.00	0.1491
25.00	0.1491
26.00	0.1491
26.50	0.1491

Reflection Coefficient Manual Procedure

This test measures the Reflection Coefficient Magnitude and Phase of a noise source from 10.0 MHz to 26.5 GHz. It may need two Vector Network Analyzers (VNAs) to achieve the frequency range required.

Some noise sources have a break point which transgress the frequency range of the Vector Network Analyzers. These have been identified in the Test Records and you need to calibrate and test in these ranges.

NOTE

The procedures refer to the key presses on an 8753ET. Other network analyzers, for example, the 8753D may have different key labelling. Please refer to the appropriate user's guide for the relevant menu maps.

Calibrating the 8753

Use the following procedure to calibrate the 8753.

NOTE

Ensure the noise source's RF connector is the same type as the VNA and connected using the preferred adapters listed in Table 2-5.

NOTE

The following example measures an N4000A. This model needs reflection and phase measured over two frequency ranges, 10.0 MHz to 1.5 GHz and 1.5 GHz to 3.0 GHz. The model you are measuring may need different frequency ranges measured, hence you need to confirm this by using your model's specifications and adjust the procedure accordingly.

Step 1. Factory Preset the Vector Network Analyzer.

1. Press the **Preset** key.

Step 2. Set the Active Channel to 1.

1. Press the **Chan 1** key.

- Step 3.** Set the measurement mode to S11.
1. Press the **Meas** key.
 2. Press the **Reflection** menu key.
- Step 4.** Set the 10.0 MHz start and 1.5 GHz stop frequencies.
1. Press the **Start** key.
 2. Press the **1, 0, M/m** keys.
 3. Press the **Stop** key.
 4. Press the **1, ., 5, G/n** keys.
- Step 5.** Set the measurement format to Polar.
1. Press **Format** key.
 2. Press the **Polar** menu key.
- Step 6.** Set the number of measurement points to 401 points.
1. Press the **Sweep Setup** key.
 2. Press the **NUMBER of POINTS** menu key.
 3. Press the **4, 0, 1, x1** keys.
- Step 7.** Set the power level to -30dBm.
1. Press the **Power** key.
 2. Press the **-, 3, 0, x1** keys.
- Step 8.** If required, connect an adapter to connect the noise source under test to port 1 of the VNA.

NOTE

The connector type (male/female) applies to the test port or adapter if fitted, not the DUT's connector.

Using the Manual Calibration Procedure
Reflection Coefficient Manual Procedure

Step 9. Select the appropriate calibration kit being used.

1. Press the **Cal** key
2. Press the **CAL KIT** menu key.
3. Press the **SELECT CAL KIT** menu key.
4. Select the calibration kit being used, for example, press the **85032B/E** menu key.

NOTE

The calibration kit selection is dependent on the noise source under test.

5. Press the **Return** menu key.

Step 10. Select a S11 port calibration.

1. Press the **Cal** key.
2. Press the **Calibrate Menu** menu key.
3. Press the **Reflection 1-Port** menu key.

Step 11. Connect the Open to the test port (or, if fitted, the adapter) and perform the open calibration.

1. Press the **Opens** menu key.
2. Select either **Open (M)** or **Open (F)** menu key.
3. When complete, press the **Done Opens** menu key.

Step 12. Connect the Short to the test port (or, if fitted, the adapter) and perform the short calibration.

1. Press the **Shorts** menu key.
2. Select either **Short (M)** or **Short (F)** menu key.
3. When complete, press the **Done Shorts** menu key.

Step 13. Connect the Load to the test port (or, if fitted, the adapter) and perform the load calibration.

1. Press the **Loads** menu key.
2. When complete, press **Done 1-port CAL**.

Step 14. Save the calibration.

1. Press the **Save/Recall** menu key.
2. Press the **Save State** menu key.
3. Note the Register the calibration data is saved in.

Measuring the DUT over 1st Frequency Range

Use the following procedure to measure the DUT.

NOTE

The following example measures an N4000A. This model needs reflection and phase measured over two frequency ranges, 10.0 MHz to 1.5 GHz and 1.5 GHz to 3.0 GHz using the 8753. The model you are measuring may need different frequency ranges measured, hence you need to confirm this by using your model's specifications and adjust the procedure accordingly.

Step 1. Connect the equipment as shown in Figure 2-2.

NOTE

Ensure the VNA's RF connector is the same type as the DUT and connected using the preferred adapters listed in Table 2-5.

Step 2. Ensure the VNA display format is set to Polar.

1. Press the **Meas** key. (This returns the format to Polar.)

Using the Manual Calibration Procedure
Reflection Coefficient Manual Procedure

Step 3. On the VNA, set the averaging to 16.

1. Press the **Avg** key.
2. Press the Averaging to **Averaging (On)**.
3. Press the **Averaging Factor** menu key.
4. Press the **1, 6, x1** keys.

Step 4. Ensure the Noise Figure Analyzer preset is set to factory settings.

1. Press the **System** key.
2. Press the **More 1 of 3** menu key.
3. Press the **Power On/Preset** menu key.
4. Set the Power On to **Power On (Preset)** and Preset to **Preset (Factory)**.

Step 5. On the NFA, press **Preset** and wait for the routine to finish.

Step 6. On the NFA, set the sweep to single and wait for the sweep to finish.

1. Press the **Sweep** key.
2. Set the Sweep to **Sweep Mode (Single)**.

Step 7. On the NFA, set the noise source to off.

1. Press the **Sweep** key.
2. Press the **Manual Meas** menu key.
3. Press the **Manual State (On)** menu key.
4. Press the **Noise Source Off** menu key.

Step 8. On the VNA, press the **Marker Search** key.

Step 9. On the VNA, press the **Search: Max** menu key.

Step 10. Record the Source OFF maximum displayed reflection magnitude and phase values on the Test Record.

Step 11. On the NFA, press the **Noise Source On** menu key.

Step 12. On the VNA, press the **Marker Search** key.

Step 13. On the VNA, press the **Search: Max** menu key.

- Step 14.** Record the Source ON maximum displayed reflection magnitude and phase values on the Test Record.
- Step 15.** On the VNA, set the marker to 10.0 MHz.
1. Press the **Marker** key.
 2. Press the **1, 0, M/m** keys.
- Step 16.** Record the Source ON maximum displayed reflection magnitude and phase values on the Test Record at 10.0 MHz.
- Step 17.** Repeat the steps for the 100.0 MHz and 1.0 GHz cardinal frequency points listed in the Test Record and note their values on the test record.
- Step 18.** On the NFA, press the **Noise Source Off** menu key.
- Step 19.** Recording the Source OFF maximum displayed reflection magnitude and phase values on the test record at 1.0 GHz.
- Step 20.** Repeat the step for the 100.0 MHz and 10.0 MHz cardinal frequency points listed in the Test Record and note their values on the Test Record.
- Step 21.** Ensure all the measured values are within the published specification.

NOTE

Repeat the calibration and measurement procedure for the other frequency ranges as applicable.

Calibrating the 8722

Use the following procedure to calibrate the 8722.

NOTE

The following example measures an N4000A. This model needs reflection and phase measured over two frequency ranges, 3.0 GHz to 7.0 GHz and 7.0 MHz to 18.0 GHz using the 8722. The model you are measuring may need different frequency ranges measured, hence you need to confirm this by using your model's Test Records and adjust the procedure accordingly.

NOTE

Ensure the noise source's RF connector is the same type as the DUT and connected using the preferred adapters listed in Table 2-5.

Step 1. Factory Preset the Vector Network Analyzer.

1. Press the **Preset** key.

Step 2. Set the Active Channel to 1.

1. Press the **Chan 1** key.

Step 3. Set the measurement mode to S11.

1. Press the **Meas** key.
2. Press the **Reflection** menu key.

Step 4. Set the 3.0 GHz start and 7.0 GHz stop frequencies.

1. Press the **Start** key.
2. Press the **3, ., 0, G/n** keys.
3. Press the **Stop** key.
4. Press the **7, ., 0, G/n** keys.

Step 5. Set the measurement format to Polar.

1. Press **Format** key.
2. Press the **Polar** menu key.

Step 6. Set the number of measurement points to 401 points.

1. Press the **Sweep Setup** key.
2. Press the **NUMBER of POINTS** menu key.
3. Press the **4, 0, 1, x1** keys.

Step 7. Set the power level to -30dBm.

1. Press the **Power** key.
2. Press the **-, 3, 0, x1** keys.

Step 8. If required, connect an adapter to connect the noise source under test to port 1 of the VNA.

NOTE

The connector type (male/female) applies to the test port or adapter if fitted, not the DUT's connector.

Step 9. Select the appropriate calibration kit being used.

1. Press the **Cal** key
2. Press the **CAL KIT** menu key.
3. Press the **SELECT CAL KIT** menu key.
4. Select the calibration kit being used, for example, press the **85032B/E** menu key.

NOTE

The calibration kit selection is dependent on the noise source under test.

5. Press the **Return** menu key.

Using the Manual Calibration Procedure
Reflection Coefficient Manual Procedure

Step 10. Select a S11 port calibration.

1. Press the **Cal** key.
2. Press the **Calibrate Menu** menu key.
3. Press the **Reflection 1-Port** menu key.

Step 11. Connect the Open to the test port (or, if fitted, the adapter) and perform the open calibration.

1. Press the **Opens** menu key.
2. Select either **Open (M)** or **Open (F)** menu key.
3. When complete, press the **Done Opens** menu key.

Step 12. Connect the Short to the test port (or, if fitted, the adapter) and perform the short calibration.

1. Press the **Shorts** menu key.
2. Select either **Short (M)** or **Short (F)** menu key.
3. When complete, press the **Done Shorts** menu key.

Step 13. Connect the Load to the test port (or, if fitted, the adapter) and perform the load calibration.

1. Press the **Loads** menu key.
2. When complete, press **Done 1-port CAL**.

Step 14. Save the calibration.

1. Press the **Save/Recall** menu key.
2. Press the **Save State** menu key.
3. Note the Register the calibration data is saved in.

Measuring the DUT over 1st Frequency Range

Use the following procedure to measure the DUT.

NOTE

The following example measures an N4000A. This model needs reflection and phase measured over two frequency ranges, 3.0 GHz to 7.0 GHz and 7.0 MHz to 18.0 GHz using the 8722. The model you are measuring may need different frequency ranges measured, hence you need to confirm this by using your model's Test Records and adjust the procedure accordingly.

NOTE

Ensure the noise source's RF connector is the same type as the DUT and connected using the preferred adapters listed in Table 2-5.

- Step 1.** Connect the equipment as shown in Figure 2-2.
- Step 2.** Ensure the VNA display format is set to Polar.
 - 1. Press the **Meas** key. (This returns the format to Polar.)
- Step 3.** On the VNA, set the averaging to 16.
 - 1. Press the **Avg** key.
 - 2. Press the **Averaging** to **Averaging (On)**.
 - 3. Press the **Averaging Factor** menu key.
 - 4. Press the **1, 6, x1** keys.
- Step 4.** Ensure the Noise Figure Analyzer preset is set to factory settings.
 - 1. Press the **System** key.
 - 2. Press the **More 1 of 3** menu key.
 - 3. Press the **Power On/Preset** menu key.
 - 4. Set the Power On to **Power On (Preset)** and Preset to **Preset (Factory)**.
- Step 5.** On the NFA, press **Preset** and wait for the routine to finish.

Using the Manual Calibration Procedure
Reflection Coefficient Manual Procedure

- Step 6.** On the NFA, set the sweep to single and wait for the sweep to finish.
1. Press the **Sweep** key.
 2. Set the Sweep to **Sweep Mode (Single)**.
- Step 7.** On the NFA, set the noise source to off.
1. Press the **Sweep** key.
 2. Press the **Manual Meas** menu key.
 3. Press the **Manual State (On)** menu key.
 4. Press the **Noise Source Off** menu key.
- Step 8.** On the VNA, press the **Marker Search** key.
- Step 9.** On the VNA, press the **Search: Max** menu key.
- Step 10.** Record the Source OFF maximum displayed reflection magnitude and phase values on the Test Record.
- Step 11.** On the NFA, press the **Noise Source On** menu key.
- Step 12.** On the VNA, press the **Marker Search** key.
- Step 13.** On the VNA, press the **Search: Max** menu key.
- Step 14.** Record the Source ON maximum displayed reflection magnitude and phase values on the Test Record.
- Step 15.** On the VNA, set the marker to 3.0 GHz.
1. Press the **Marker** key.
 2. Press the **3, ., 0, G/n** keys.
- Step 16.** Record the Source ON maximum displayed reflection magnitude and phase values on the Test Record at 3.0 GHz.
- Step 17.** Repeat the steps for the 4.0 GHz, 5.0 GHz, 6.0 GHz, and 7.0 GHz cardinal frequency points listed in the Test Record and note their values on the Test Record.
- Step 18.** On the NFA, press the **Noise Source Off** menu key.
- Step 19.** Recording the Source OFF maximum displayed reflection magnitude and phase values on the test record at 7.0 GHz.

Step 20. Repeat the step 13 for the 4.0 GHz, 5.0 GHz, 6.0 GHz, and 7.0 GHz cardinal frequency points listed in the Test Record and note their values on the Test Record.

Step 21. Ensure all the measured values are within the published specification.

NOTE

Repeat the calibration and measurement procedure for the other frequency ranges as applicable.

Using the Manual Calibration Procedure
Reflection Coefficient Manual Procedure

Introduction

This section describes the procedure used to program data into an Agilent N400xA Series Smart Noise Sources.

WARNING

This procedure is performed at the your own risk. Failure to correctly follow this procedure may render the noise source inoperative.

Equipment Required

The following equipment is required to program data into an Agilent N400xA smart noise source series:

- An Agilent NFA Series Noise Figure Analyzer.
- An 11730A Noise Source cable to connect the noise source to the NFA.
- A 3.5 inch formatted floppy disk.
- A personal computer.

Data Programming Process

The new calibration data to be programmed into the smart noise source must be in the correct format. Formatting the data can only be performed on a PC. When the data is in the correct format it is copied to the NFA, and then programmed into the smart noise source

Formatting the Data

An example data file is shown in page 52 and shows the cardinal frequency points of an 18.0 GHz SNS. This example file can be used as a template for formatting the data to be programmed into the smart noise source. Alternatively, the data currently contained into the SNS can be copied to a PC and used as a template, using the following procedure.

- Step 1.** Connect the smart noise source to the NFA.
- Step 2.** Confirm the Source Preference is set to SNS. To do this follow Step 3 through to Step 5.
- Step 3.** Press the **ENR** key.
- Step 4.** Press the **SNS Setup** menu key.
- Step 5.** Ensure Preference is set to **Preference (SNS)**.
- Step 6.** Save the data from the smart noise source by pressing **File** key.
- Step 7.** Press the **Save** menu key.
- Step 8.** Press the **ENR** menu key.
- Step 9.** Press the **SNS** menu key.
- Step 10.** Using the Alpha Editor, name the file, for example, `template.enr`.
- Step 11.** Transfer this template file to your PC from the floppy disk.
- Step 12.** Save a copy of this file in your PC.

The file can be edited in an ASCII text editor, for example, Notepad.

Editing the Data File

There are only certain fields in the data file which you should edit. The example data file shown in page 52, shows the following information:

- The NFA model.
- The NFA serial number.
- The NFA firmware revision.
- The date that the data file was created.
- The serial number of the smart noise source.
- The model number of the smart noise source.
- The calibration date.
- The temperature the calibration was carried out under.
- The humidity the calibration was carried out under.

The fields that are edited in the data file are:

- [Caldate 20010227] - Calibration Date (yyyymmdd)
- [Temperature 23.000000] - Temperature the calibration was performed at.
- [Humidity 30.000000] - Humidity the calibration was performed at.

NOTE

Do not change the value shown in the field marked [Current xxxx], as this affects the smart noise source's performance.

The other fields in the data file contain the frequency points, ENR (dB) values, ENR uncertainties, and Reflection and Phase values. The frequency points can be added or removed as required. The maximum number of points is 81.

NOTE

Each field must have a data entry, for this process to work correctly.

Programming the Data File into the SNS

Program the data file into the SNS use the following procedure.

- Step 1.** Save the new data file as 'writesns.enr' to a floppy disk.
- Step 2.** Insert the floppy disk in the NFA's floppy drive.
- Step 3.** Press the **System** key.
- Step 4.** Press the **More 1 of 3** menu key.
- Step 5.** Press the **More 2 of 3** menu key.
- Step 6.** Press the **Service** menu key.
- Step 7.** Enter the password by pressing -, 2, 0,1, 0 on the numeric key pad.
- Step 8.** Press the **Enter** key.
- Step 9.** Press the **Service** menu key.
- Step 10.** Press the **More 1 of 2** menu key.
- Step 11.** Press the **Write to SNS** menu key and follow the instructions on the display.

Verifying the SNS was Programmed

To check if the SNS was programmed successfully, do the following:

- Step 1.** Press the **ENR** key.
- Step 2.** Press the **ENR Table** menu key.
- Step 3.** Press the **Fill Table From SNS** menu key.

The ENR Table should show the correct data.

Manually Programming Data into an Agilent Smart Noise Source Example

Example

This example is an SNS ENR file saved to a diskette:

NOTE

The values shown in the example are representative of their position in the file.

```
# ENR Data File
# Created by N8975A NFA Series Noise Figure Analyzer
# Serial Number GB40390135 Firmware Revision A.01.01
# 13:37:07 Mar 28, 2002
# Format is: Frequency (Hz), ENR (dB), ENR Unc (dB), # On Refl.Mag (lin),
# On Refl.Phase (deg), Off Refl.Mag (lin), # Off Refl.Phase (deg), On Refl.Mag Unc (lin),
# On Refl.Phase Unc (deg), Off Refl.Mag Unc (lin), # Off Refl.Phase Unc (deg)
```

```
[Filetype ENR]
[Version 1.1]
[Serialnumber US411130226]
[Model N4001A]
[Caldate 20000727]
[Trackingnum 10]
[Temperature 23.000000]
[Humidity 63.000000]
[Current 2688]
```

```
10000000,15.281,0.193,0.0450,-136.0,0.0450,-136.0,0.0030, -6.0, 0.0070, +6.0
100000000, 15.291, 0.190, 0.0358, +168.0, 0.0358, +168.0, 0.0040, +4.6, 0.0050, -4.6
1000000000, 15.118, 0.151, 0.0398, +39.6, 0.0398, +39.6, 0.0100, +4.5, 0.0067, +1.5
2000000000, 14.999, 0.168, 0.0377, 0.168, 0.0377, -85.7, 0.0056, +0.9, 0.0086, +1.9
3000000000, 14.879, 0.172, 0.0267, +150.6, 0.0267, +150.6, 0.0080, -9.2, 0.0090, -1.2
4000000000, 14.795, 0.173, 0.0130, -18.1, 0.0130, -18.1, 0.0013, +16.0, 0.0063, +10.0
5000000000, 14.818, 0.179, 0.0359, +169.5, 0.0359, +169.5, 0.0024, -9.3, 0.0035, -0.3
6000000000, 14.846, 0.181, 0.0556, +63.7, 0.0556, +63.7, 0.0041, +10.3, 0.0067, -4.3
7000000000, 14.895, 0.180, 0.0430, -37.0, 0.0430, -27.0, 0.0079, -2.3, 0.0049, -2.3
8000000000, 15.016, 0.198, 0.0232, -160.3, 0.0232, -160.3, 0.0091, -3.8, 0.0053, -1.8
9000000000, 15.134, 0.201, 0.0122, +71.4,0.0122, +71.4, 0.0037, +17.3, 0.0057, +7.3
10000000000, 15.253, 0.194, 0.0080, +116.2, 0.0080, +116.2, 0.0048, -1.4, 0.0056, -5.4
11000000000, 15.249, 0.243, 0.0241, +65.7, 0.0241, +65.7, 0.0059, +1.5, 0.0049, +44.5
12000000000, 15.349, 0.240, 0.0196, +8.8, 0.0196, +8.8, 0.0057, +3.2, 0.0077, +2.2
13000000000, 15.383, 0.188, 0.0217, -5.4, 0.0217, -5.4, 0.0062, -6.9, 0.0045, -1.9
14000000000, 15.355, 0.178, 0.0228, -66.6, 0.0228, -66.6, 0.0075, +11.2, 0.0065, +1.2
15000000000, 15.367, 0.187, 0.0141, +141.6, 0.0141, +141.6, 0.0036, -3.2, 0.0029, -1.2
16000000000, 15.421, 0.182, 0.0251, +6.4, 0.0251, +6.4, 0.0030, +7.2, 0.0042, -1.21
```

5

Using the Agilent N2002A Noise Source Demonstration Software

This chapter describes how to setup and configure the *Agilent N2002A Noise Source Demonstration Software*.

Getting Started

This section describes the software requirements, the system requirements, and the required directory structure to setup and configure the *Agilent N2002A Noise Source Demonstration Software*.

The *Agilent N2002A Noise Source Demonstration Software* is written in Agilent VEE Pro Version 6.0 and is supplied as an Agilent VEE Pro Version 6.0 file (.vee) and as an Agilent VEE Run Time executable file (.vxe). The Agilent VEE Run Time executable file (.vxe) can not be modified. The Agilent VEE file need to have Agilent VEE Pro 6.0 installed before it can run. The file can be modified. The VEE Run Time Executable file requires VEE Pro 6.0 Run Time environment. The Agilent VEE Run Time executable file can not be modified.

NOTE

The *Agilent N2002A Noise Source Demonstration Software* is supplied 'as is'. Agilent Technologies offers no support or warranty in the event of user modification and any problems arising as a result of user modification.

Additional Software Requirements

The Agilent IO libraries must be installed to allow instrument control.

System Requirements

The system requirements to run the *Agilent N2002A Noise Source Demonstration Software* are:

- PC with 120 MHz Pentium® processor (266 MHz Pentium II or higher recommended)
- Microsoft® Windows® 2000 or Windows XP®
- 64 MB RAM with Windows 2000/XP
- GPIB interface card (Agilent 82350A) or Agilent 82357A USB/GPIB interface.
- Agilent IO Libraries

NOTE

Agilent Technologies recommend that the System standby feature on your Windows OS is disabled. This option is found under the power options in the Control Panel.

Test Equipment

In Chapter 2 , “The Noise Source Calibration Process and Recommended Test Equipment,” there are tables listing the recommended equipment.

Limited substitution is supported when using the *Agilent N2002A Noise Source Demonstration Software*.

The *Agilent N2002A Noise Source Demonstration Software* was written specifically for the following Agilent test equipment:

- ENR Measurement:**
- N8975A Noise Figure Analyzer
 - N2002A Noise Source Test Set
 - 11713A Attenuator/Switch Driver

Directory Structure Required

Figure 5-1 shows the required directory structure you must create on the C: drive of the computer. This allows you use to run the *Agilent N2002A Noise Source Demonstration Software*. This is required for both the versions of the software.

Figure 5-1 **Directory Structure**

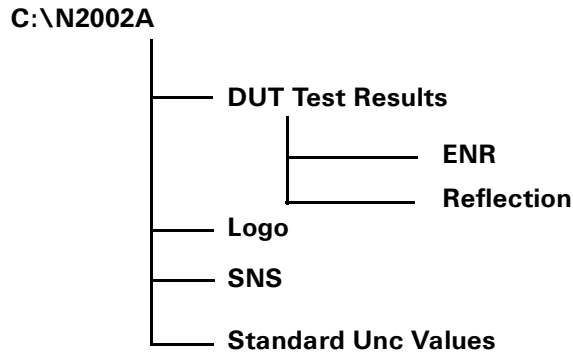

NOTE

Copy the files named *agilent.gif* and *spark.gif* from the logo directory on the N2002A CD to the logo directory on the computer used to run the *Agilent N2002A Noise Source Demonstration Software*.

Opening the VEE Pro 6.0 (.vee) Software File

To start the *Agilent N2002A Noise Source Demonstration Software* you need to open the Agilent VEE Pro 6.0 programme. To do this do the following:

- Step 1.** Open the file by clicking File Open from the CD.
- Step 2.** Select the file name (or use the default).
- Step 3.** Select the Debug/Run or the  icon or Cntl-G.

Figure 5-3 show the Main window.

Setting up the Address Drivers

On initial opening of the *Agilent N2002A Noise Source Demonstration Software* the GPIB controlled test equipment needs configured with their address drivers. This is explained in the following procedure:

- Step 1.** The initial time the program is ran a Caution, as shown in Figure 5-2, is displayed informing you that a driver for the N8975A can not be found.

Figure 5-2 **A VEE Driver Caution**

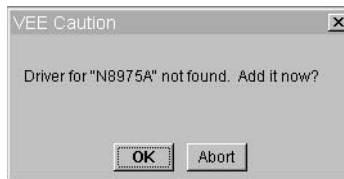

NOTE

If you do not have the required equipment connected when the Caution is displayed, either enter a GPIB address for the equipment, or allow the address to remain set at 0.

- Step 2.** To add a driver, click **OK** to display the Instrument Properties box. You need to enter the address of the N8975A.
- This is the only data you need to enter.
- Step 3.** The address can be a three or four digit number and consists of the logical unit of the GPIB card plus the address of the N8975A. Table 5-1 provides a list of default instrument address settings.
- Step 4.** Click **OK** when the correct address has been entered in the Instrument Properties box.

Table 5-1 Default Addresses

Instrument	GPIB Address	Agilent/HP GPIB Card Address
N8975A	08	708
Switch 11713A	28	728
8722	24	724
8753	16	716

- Step 5.** Another Caution is displayed informing you that a driver for the 11713A can not be found. Enter the correct GPIB address.
- Step 6.** Save the file using the Save in VEE window when the file loading is complete.

Configuring the VEE Pro 6.0 Run Time File IO

Use the procedure to configure the IO.

- Step 1.** Select the Agilent VEE Pro 6.0 Run Time Config program.
- Step 2.** Select IO Configuration.
- Step 3.** Use Instrument.
- Step 4.** Add to create an entry for each piece of equipment. Use the instrument names shown in Table 5-1 and enter the appropriate GPIB address.

Before running the Agilent N2002A Noise Source Demonstration Software

Before you run the *Agilent N2002A Noise Source Demonstration Software* ensure the test equipment is correctly connected. If a GPIB connection fails to establish a warning appears on the display, Figure 5-3 shows a typical warning. The equipment connections are shown in Figure 2-1 for ENR Measurement. To perform an ENR Measurement the only equipment needed is the N8975A, 11713A, and N2002A.

Figure 5-3

Communication Warning!

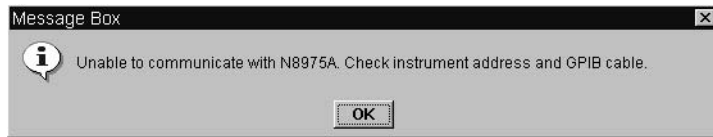

NOTE

Ensure the reference standard's ENR table is loaded into the N8975A before running the software. See "Loading the Reference Standard's ENR Data" on page 16 for more information on doing this.

If the reference standard is changed while you are running the software, ensure that the correct reference standard's ENR table is loaded into the NFA.

The ENR Measurement Procedure

The following procedure explains how to make an ENR measurement. Each step in the procedure is explained in greater detail in the referenced section. In the pdf file of this manual, each of the referenced sections has a link to return you to this procedure.

To start the procedure you must have the Main Start Up Window displayed, this is shown in Figure 5-5.

Step 1. Enter the Test Details. The entered details are shown on the Measurement displays.

The section, “Test Details” on page 65 explains this in detail.

Step 2. Select ENR Measurement on the Main Start Up Window.

The section, “ENR Measurement” on page 67 explains this in detail.

Step 3. Select a Measurement Reference Standard.

The section, “Selecting and Measuring the Reference Standard” on page 69 explains this in detail.

Step 4. Select the Reference Standard Type.

The section, “Selecting the Reference Standard” on page 71 explains this in detail.

Step 5. Enter ENR data for the selected Reference Standard.

The section, “Loading the Reference Standard’s ENR Data” on page 16 explains this in detail.

Step 6. Enter Uncertainty data of selected Reference Standard.

The section, “Selecting Reference Standard Measurement Uncertainty Data” on page 76 explains this in detail.

Step 7. Measure the Reference Standard.

The section, “Performing Reference Standard Measurement” on page 77 explains this in detail.

Step 8. On the display are both items green?

If **Yes**, proceed to the next step. If **No**, repeat the steps again.

Step 9. Select the type of DUT to be measured.

The section, “Selecting the DUT to be Measured” on page 78 explains this in detail.

Step 10. Measure the DUT.

The section, “Measuring a DUT” on page 82 or “Making Multi Measurement on a DUT” on page 87 explains this in detail.

Step 11. Save the results.

Step 12. Copy data to SNS. The section, “Copying Data to SNS” on page 85 explains this in detail

Running the Agilent N2002A Noise Source Demonstration Software

To start the Agilent VEE Pro 6.0 file use the Run or Start from within Agilent VEE Pro 6.0.

The Agilent VEE Pro 6.0 run time file is started using windows explorer.

When the *Agilent N2002A Noise Source Demonstration Software* is running the main window shown Figure 5-5 is visible.

Ensure all the test equipment ia powered up and allow to warm up for one hour. You also need to run the N8975A YTF Alignment routine before performing a measurements. The procedure to run the YTF alignment is as follows

- Step 1.** Press the **System** key.
- Step 2.** Press the **Alignment** menu key.
- Step 3.** Press the **Align YTF** menu key. This menu key needs pressed a second time, this is to avoid accidental damage.
- Step 4.** Press the **Save YTF Alignment** menu key when Alignment routine is complete.

NOTE

Figure 5-4 is an example of the warning displayed if a N8975A has been powered up for less than one hour. It is recommended that no measurements are made if this warning is shown.

Figure 5-4

A Warm Up Warning

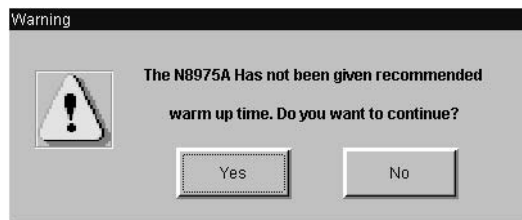
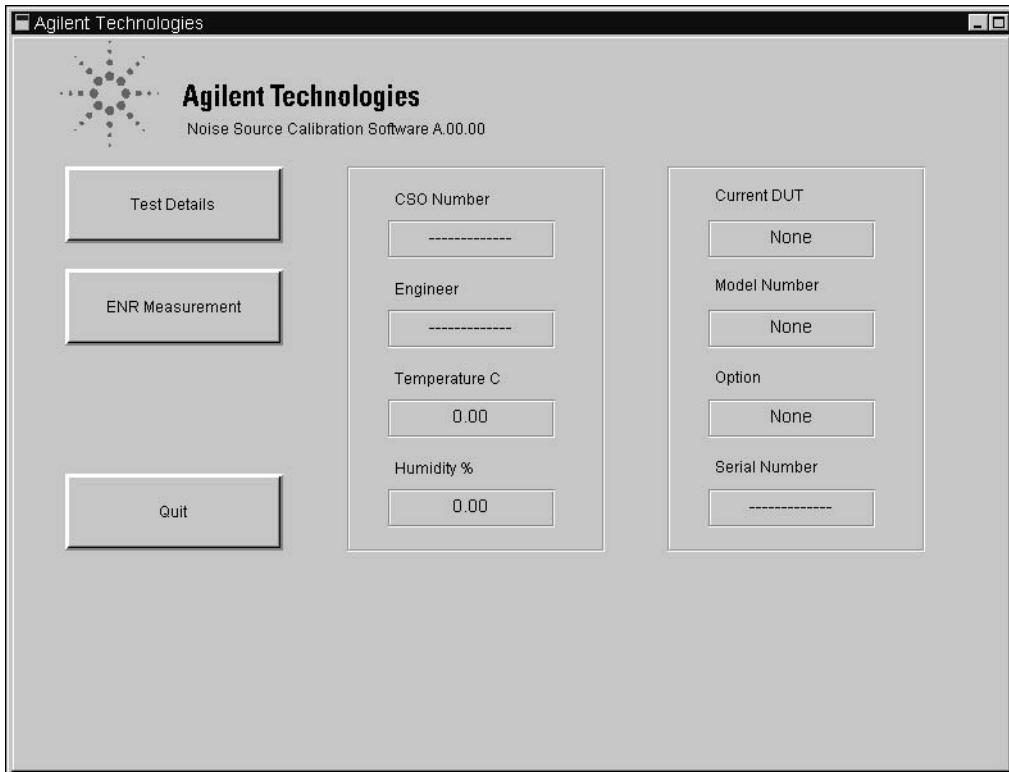

Figure 5-5 The Main Start Up Window Display



The options available to choose from are:

- Test Details** This allows to enter the details described in “Test Details” on page 65. After these details are entered they are shown on the Measurement displays. The details are saved along with the measurement results. Entering these details is not required for correct operation.
- ENR Measurement** This selects the ENR display and allows you to configure and perform ENR Measurements.

Using the Agilent N2002A Noise Source Demonstration Software
Running the Agilent N2002A Noise Source Demonstration Software

Quit

Stops the software

The other information displayed on the Main Start Up Window.

The central display is any information entered in the Test Detail. This includes the job number and the name of the engineer performing the measurement. The environmental conditions the measurement is performed under are also displayed.

The right hand portion of the display is information relating to the noise source under test (DUT). This includes the noise source manufacturer, the type of noise source, any options, and the noise source serial number.

To return to “The ENR Measurement Procedure” on page 60, click the pdf hot-link.

Test Details

The test details are entered into the fields and are displayed on the Measurement displays. The Test Details display is shown in Figure 5-6. The test details are saved with the measurement results.

NOTE

Entering these details is not required for correct operation.

Figure 5-6 Test Detail Display

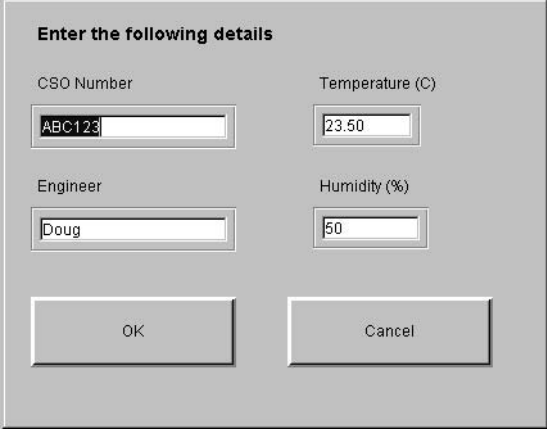

The screenshot shows a dialog box titled "Enter the following details". It has four input fields arranged in a 2x2 grid. The top-left field is labeled "CSO Number" and contains the text "ABC123". The top-right field is labeled "Temperature (C)" and contains the value "23.50". The bottom-left field is labeled "Engineer" and contains the name "Doug". The bottom-right field is labeled "Humidity (%)" and contains the value "50". Below the input fields are two buttons: "OK" on the left and "Cancel" on the right.

The Test Detail fields are:

CSO Number

This allows you to have traceability of the **Job Number**.

Engineer

This allows you to have traceability of the **Engineer**.

Temperature

This allows to enter the ambient temperature where the calibration is made. The default value is 23.5°C.

Humidity

This allows to enter the ambient humidity where the calibration is made. The default value is 50.0%.

Clicking the **OK** button accepts the data entered in the display and returns to the Measurement display.

Clicking the **Cancel** button returns to the Measurement display without accepting the data. No data is shown on the Measurement displays.

To return to “The ENR Measurement Procedure” on page 60, click the pdf hot-link.

ENR Measurement

The ENR measurement process is based on making a measurement using a noise source with known ENR values (The Reference Standard), then making another measurement on a noise source with unknown ENR values (the Device Under Test (DUT)). The DUT's ENR values are now calculated on completion of the measurement.

The first step to make an ENR measurement is to select ENR Measurement from the Main Start Up Window. Figure 5-7 shows the ENR Measurement display.

NOTE

Figure 5-4 is an example of the warning displayed if a N8975A has been powered up for less than one hour. It is recommended that no measurements are made if this warning is shown.

Figure 5-7 The ENR Measurement Display

The screenshot shows the 'ENR Measurement' software interface. The window title is 'Agilent Technologies'. The main area is titled 'ENR Measurement' with the instruction 'Select from the following options'. On the left, there are four buttons: 'Select and Meas Standard', 'Select and Meas DUT', 'Set SNS Bias Current', and 'Return'. On the right, there are two columns of input fields. The top column contains 'CSO Number' (ABC123), 'Temperature (C)' (23.50), 'Engineer' (Doug), and 'Humidity (%)' (50.00). The bottom column contains 'Current Standard' (None), 'Model Number' (None), 'Option' (None), and 'Serial Number' (-----). The right column contains 'Current DUT' (None), 'Model Number' (None), 'Option' (None), and 'Serial Number' (-----).

Using the Agilent N2002A Noise Source Demonstration Software
Running the Agilent N2002A Noise Source Demonstration Software

The options available to choose from are:

- | | |
|---------------------------------|--|
| Select and Meas Standard | This selects another display where you can configure and measure a reference standard. |
| Select and Meas DUT | This selects another display where you can configure and measure a device under test. The device under test (DUT) is the noise source you are measuring. |
| Set SNS Bias Current | This selects a new display where a new SNS bias current can be entered. |
| Return | Returns you to the previous display.

The upper display is the information entered in the Test Details. This includes the job number and the name of the engineer performing the measurement. The environmental conditions the measurement is performed under are also displayed.

The two lower displays shows information relating to the noise source used as the reference standard and the noise source (DUT) being measured. This includes the noise source manufacturer, the type of noise source, any options, and the noise source serial number.

To return to “The ENR Measurement Procedure” on page 60, click the pdf hot-link. |

Selecting and Measuring the Reference Standard

Clicking the **Select and Meas Standard** button on the ENR Measurement display, produces a display similar to Figure 5-8.

This process step must be followed before a DUT can be measured.

1. A reference standard must be selected and a measurement performed on it.
2. The ENR measurement uncertainty data must be entered for the reference standard.

Figure 5-8 **Select and Measure Reference Standard**

Select and Measure Reference Standard

Select from the following options

Select Std Type

ENR Uncertainty Data

Measure Reference Std

Return

Current Standard
None

Model Number
None

Option
None

Serial Number

Standard meas data available?

Standard uncertainty data available?

The options available to choose from are:

Select Std Type

This selects another display allowing you to enter the reference standard's details.

Using the Agilent N2002A Noise Source Demonstration Software
Running the Agilent N2002A Noise Source Demonstration Software

ENR Uncertainty Data	This allows access to other displays allowing you to enter and manipulate the reference standard's ENR measurement uncertainty data.
Measure Reference Standard	This initiates measurement of the reference standard. A reference standard must be selected before a measurement can be made.
Return	Returns you to the previous display. The upper display shows information relating to the reference standard. This includes the noise source manufacturer, the type of noise source, any options, and the noise source serial number. The lower display shows the current status of data relating to the reference standard. The indicators are:
Standard Meas Data Available?	A DUT measurement is not possible until the reference standard's uncertainty date has been entered and the measurement has been made on the reference standard. This indicator is red until the measurements have been made. When these measurements are complete the indicator is green. The indicator returns to red when a new reference standard is selected.
Standard Uncertainty Data Available?	A DUT measurement is not possible until the ENR measurement uncertainty values for the reference standard are available. This indicator is red until the measurement uncertainty values are available. When these measurements uncertainty values are available the indicator is green. The indicator returns to red when a new reference standard is selected. To return to "The ENR Measurement Procedure" on page 60, click the pdf hot-link.

Selecting the Reference Standard

A reference standard must be selected before proceeding. See “Reference Standard Noise Source Selection” on page 22 for more information on selecting the reference standard.

Clicking the **Select Std Type** from the **Select and Measure Reference Standard** window shows a display similar to Figure 5-9.

Figure 5-9

Select Reference Standard Type and Serial Number

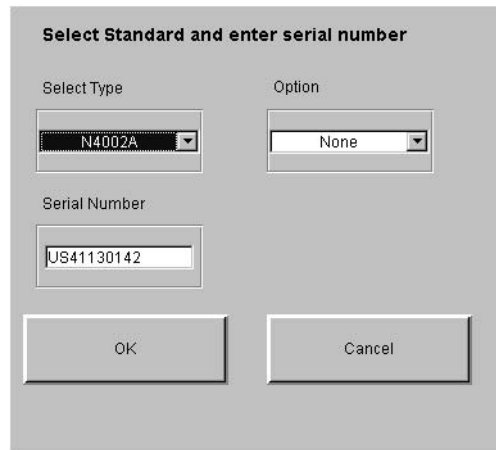

The screenshot shows a dialog box titled "Select Standard and enter serial number". It contains three input fields: "Select Type" with a dropdown menu showing "N4002A", "Option" with a dropdown menu showing "None", and "Serial Number" with a text box containing "US41130142". At the bottom are "OK" and "Cancel" buttons.

The options available to choose from are:

Select Type

This allows you to select the type of reference standard. The options to choose from are 346A, 346B, 346C, N4000A, N4001A, N4002A, and Other. The Other option covers all other manufacturer’s noise sources or Agilent noise sources operating at frequencies other than the standard cardinal values. See “Selecting Other” on page 90 for a further explanation.

Option

A list of Options available are shown. The available options depend on the type of reference standard selected.

Using the Agilent N2002A Noise Source Demonstration Software
Running the Agilent N2002A Noise Source Demonstration Software

Serial Number

The Serial Number of the reference standard is entered in this field.

Clicking the **OK** button accepts the entered data and returns you to the previous display.

Clicking the **Cancel** button ignores any changes and returns you to the previous display.

To return to “The ENR Measurement Procedure” on page 60, click the pdf hot-link.

Entering Reference Standard Uncertainty Data

A DUT measurement is not possible until the reference standard's ENR measurement uncertainty data is available. This indicator is red until the measurement uncertainty data is available. When the measurement uncertainty data is available the indicator is green. The indicator returns to red when a new reference standard is selected. Figure 5-10 shows a typical display before uncertainty date has been entered.

Figure 5-10 Reference Standard ENR Uncertainty Data

The screenshot shows a software window titled "Agilent Technologies" with a sub-window titled "Reference Standard ENR Uncertainty Data". The window contains the following elements:

- A prompt: "Select from the following options"
- Four buttons on the left: "Enter Uncertainty Data" (highlighted with a red border), "Save Uncertainty Data", "Load Uncertainty Data", and "Return".
- Form fields on the right:
 - "Current Standard" with a dropdown menu showing "Agilent".
 - "Model Number" with a text box containing "N4002A".
 - "Option" with a dropdown menu showing "None".
 - "Serial Number" with a text box containing "US41130142".
- A checkbox labeled "Standard uncertainty data available?" which is currently unchecked, with a "No" button next to it.

The options available to choose from are:

Enter Uncertainty Values Selecting this produces a display of the number of frequency points in the reference standard selected. There are three possible displays:

1. Covering the Agilent 346A, 346B, N4000A, and N4001A noise sources (10.0 MHz to 18.0 GHz). This display type is shown in Figure 5-11.
2. Covering the Agilent 346C and N4002A noise sources (10.0 MHz to 26.5 GHz).
3. Covering **Other** noise source types and frequency points. See “Selecting Other” on page 90 for an explanation of this.

Save Uncertainty Data Select this to save the reference standard’s measurement uncertainty data to a file. This key is unavailable until Uncertainty data has been entered. The file is saved to
C:\N2002A\Standard\Uncertainty Values\.

The measurement uncertainty data is saved with the model number and serial number of the reference standard.

Load Uncertainty Data Select this if the reference standard’s uncertainty data is available on file (C:\N2002A\Standard\Uncertainty Values\).

NOTE Ensure the reference standard’s model number and serial number match the values in the saved data.

Return

Returns you to the **Select and Measure Standard** display.

The upper display shows the current reference standard's data. The data is the manufacturer, noise source model, option, and serial number.

The lower display indicates if the uncertainty data is valid for the selected reference standard. The indicator is green when the data is valid.

A DUT measurement is not possible until the ENR measurement uncertainty values for the reference standard are available. The indicator is red until measurement uncertainty values are available. When ENR measurement uncertainty data is available for the reference standard, and the indicator on the **Standard uncertainty data available?** display is green. The indicator returns to red when a new reference standard is selected.

NOTE

Measurement uncertainty data need not be entered before performing a measurement on the reference standard. However, measurement uncertainty data for the reference standard has to be available before a DUT measurement can be made.

To return to “The ENR Measurement Procedure” on page 60, click the pdf hot-link.

Selecting Reference Standard Measurement Uncertainty Data

Clicking **Enter Uncertainty Values** on the **Reference Standard ENR Uncertainty Data** displays a table of fields similar to Figure 5-11. Data must be entered in the fields or measurements cannot be made. After the uncertainty data has been entered, click **OK**. This returns you to the previous display and the **Standard uncertainty data available?** indicator is now green.

Figure 5-11 Typical Reference Standard ENR Uncertainty Data

Frequency (GHz)	Uncertainty Value
0.01	0.08800000
0.10	0.130
1.00	0.110
2.00	0.096
3.00	0.068
4.00	0.110
5.00	0.110
6.00	0.069
7.00	0.068
8.00	0.077
9.00	0.063
10.0	0.056
11.0	0.059
12.0	0.075
13.0	0.070
14.0	0.090
15.0	0.071
16.0	0.080
17.0	0.071
18.0	0.100
19.0	0.170
20.0	0.170
21.0	0.180
22.0	0.170
23.0	0.130
24.0	0.190
25.0	0.160
26.0	0.160
26.5	0.210

To return to “The ENR Measurement Procedure” on page 60, click the pdf hot-link.

Performing Reference Standard Measurement

When a reference standard has been selected with its ENR table data and Uncertainty Data entered, a measurement can be made. The measurement process is started by clicking the **Measure Reference Standard** button. This button is on the **Select and Measure Standard** display. The measurement results are not displayed during this process. However, a **Measuring frequency point** counter, shown in Figure 5-12, is displayed indicating a measurement is being performed. When testing is complete the **Measurement Complete?** indicator changes from red to green. Click **Return** to return to the **Select and Measure Reference Standard** display.

NOTE

A Reference Standard's measurement need not be repeated before every DUT measurement. However, Agilent Technologies recommend for best result a Reference Standard's has been performed regularly.

Figure 5-12 **Measure Reference Standard Display**

The screenshot shows a software interface titled "Measure Reference Standard". On the left, there are two status indicators: "Measuring frequency point" with a counter showing "29 of 29", and "Measurement complete?" with a "Yes" button. At the bottom left is a "Return" button. On the right, a panel displays details for the "Current Standard": "Agilent", "Model Number: N4002A", "Option: None", and "Serial Number: US41130142".

To return to “The ENR Measurement Procedure” on page 60, click the pdf hot-link.

Selecting the DUT to be Measured

When the reference standard measurement is complete, the DUT can be measured. Clicking **Select and Meas DUT** on the ENR Measurement display shows a similar display to Figure 5-13.

Figure 5-13 **Select and Measure DUT**

Select and Measure DUT

Select from the following options

Select DUT

DUT Measurement

DUT Multi Measurement

Return

Current DUT
None

Model Number
None

Option
None

Serial Number

DUT measurement complete? No

The options available to choose from are:

- Select DUT** This selects another display where you can enter information about the device under test (DUT).
- DUT Measurement** Starts a single DUT measurement. The DUT is measured only on one occasion, at all the designated frequency points.
- DUT Multi Measurement** Starts a multiple DUT measurement. The DUT can be repeatedly measured, up to a maximum of twelve repeats, at all the designated frequency points.

Return

Returns you to the previous display.

The upper display is any information entered in the Test Details. This includes the job number and the name of the engineer performing the measurement. The environmental conditions the measurement is performed under are also displayed.

To return to “The ENR Measurement Procedure” on page 60, click the pdf hot-link.

Selecting the DUT

NOTE

Any noise source can be selected as a reference standard. However, a warning is displayed if you measure a DUT with a different frequency range. For example, if you use a 346B as a reference standard and attempt to measure a 346C a caution is displayed stating that the measurements are limited to 18.0 GHz.

Figure 5-14 Select DUT Type and Serial Number

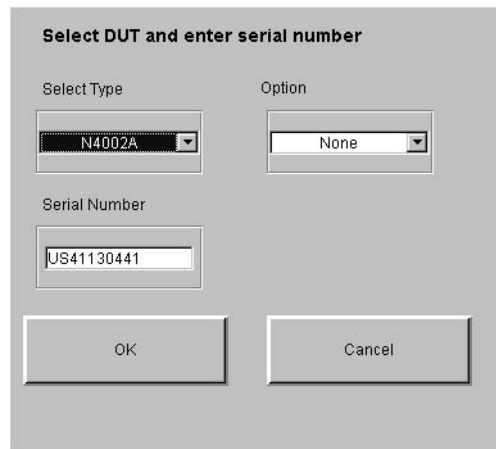

The screenshot shows a dialog box titled "Select DUT and enter serial number". It contains three input fields: "Select Type" with a dropdown menu showing "N4002A", "Option" with a dropdown menu showing "None", and "Serial Number" with a text box containing "US41130441". At the bottom are "OK" and "Cancel" buttons.

The options available to choose from are similar to the “Selecting and Measuring the Reference Standard” on page 69.

Select Type

This allows you to choose the DUT type being measured. The choices are 346A, 346B, 346C, N4000A, N4001A, N4002A, and Other.

Other allows you to test other manufacturer’s noise sources or Agilent noise sources using at non-standard frequency values. See “Selecting Other” on page 90 for an explanation of this.

Option

A list of available options are shown. The options available depend on the type of DUT selected.

Serial Number

The Serial Number of the DUT is entered in this field.

Clicking the **OK** button accepts the data that has been entered and returns you to the **Select and Measure DUT** display. This data is displayed in the window.

Clicking the **Cancel** button ignores the changes and returns you to the **Select and Measure DUT** display.

To return to “The ENR Measurement Procedure” on page 60, click the pdf hot-link.

Measuring a DUT

Selecting the **DUT Measurement** button starts a single DUT measurement and displays the results as they are completed. A measurement is made on the DUT at the first measurement frequency point. The DUT's ENR and ENR measurement uncertainty results are calculated for the DUT at this frequency point. The results are displayed with the frequency point the measurement was made at. The process is repeated for all the measurement frequency points. The display is updated with results, one frequency point at a time. When the final result is obtained a display similar to Figure 5-15 is presented.

If a DUT measurement is not possible a warning message is displayed. The warning message indicates the reason the DUT measurement is not possible.

Figure 5-15 An Example of Result Data

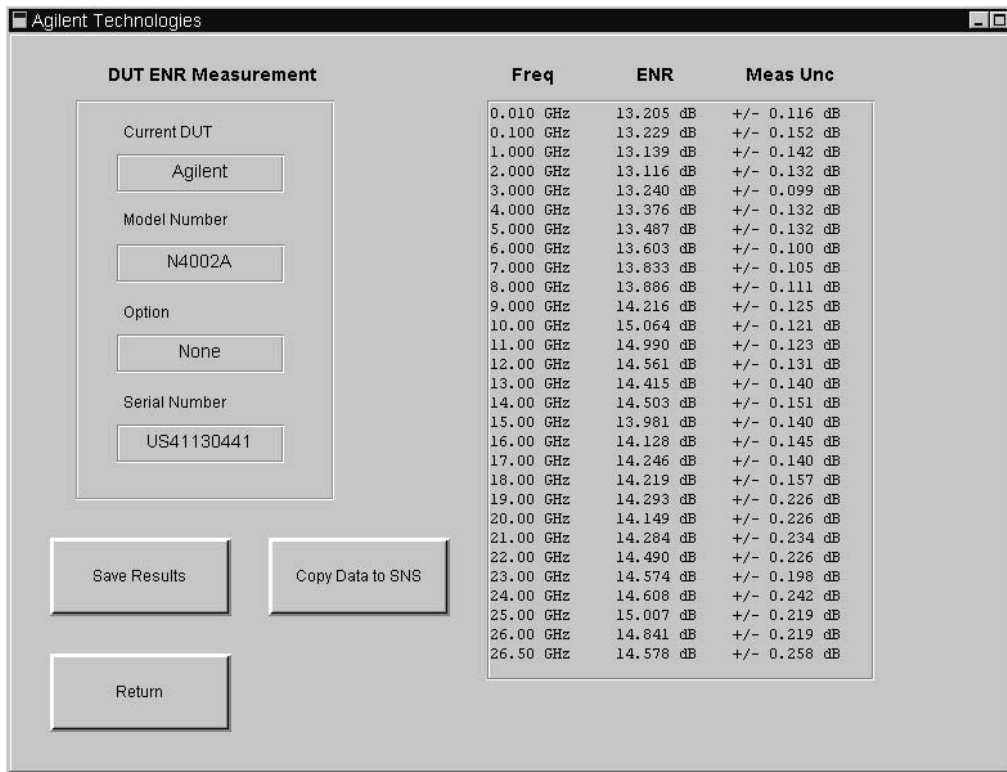

The options available to choose from are:

Save Results

This option is not available until the DUT measurement is completed. The ENR values and measurement uncertainty values are saved with the measurement frequency points. Also, saved are the DUT's identification details, the reference standard's details, the job details, the environmental conditions the test was performed in, the date of the test, and the software revision. An example of a test result file is shown in Figure 5-16.

Test results are saved as a text files to:

C:\N2002A\DUT Test Results\ENR\

The results are saved under an automatically generated filename. The filename is made up from the DUT model number, the DUT serial number, and the date the test results were made, for example, N4002A_US4110000_yyyymmdd_hh_mm_ss.txt.

Using the Agilent N2002A Noise Source Demonstration Software

Running the Agilent N2002A Noise Source Demonstration Software

Figure 5-16 Example of a Single ENR Measurement Result Data

```

Agilent Technologies Noise Source Calibration System
ENR Measurement Results

CSO Number - 233
Engineers Name - Doug
Cal Software Rev No - A.00.00

DUT Manufacturer - Agilent
DUT Type - N4002A
DUT Serial Number - XXXXX

Ref Std Manufacturer - Agilent
Ref Std Type - N4002A
Ref Std Serial Number - Proto D

Test Date - 01/May/2003
Temperature - 23.50 C
Humidity - 50.23 %
    
```

Frequency GHz	ENR dB	Unc dB
0.01	13.199	+/- 0.116
0.10	13.232	+/- 0.152
1.00	13.139	+/- 0.142
2.00	13.110	+/- 0.132
3.00	13.244	+/- 0.099
4.00	13.378	+/- 0.132
5.00	13.487	+/- 0.132
6.00	13.584	+/- 0.100
7.00	13.843	+/- 0.105
8.00	14.041	+/- 0.111
9.00	14.263	+/- 0.125
10.00	14.679	+/- 0.121
11.00	15.118	+/- 0.123
12.00	15.004	+/- 0.131
13.00	14.699	+/- 0.140
14.00	14.695	+/- 0.151
15.00	14.261	+/- 0.140
16.00	14.301	+/- 0.145
17.00	14.400	+/- 0.140
18.00	14.403	+/- 0.157
19.00	14.607	+/- 0.226
20.00	14.490	+/- 0.226
21.00	14.776	+/- 0.234
22.00	15.125	+/- 0.226
23.00	15.190	+/- 0.198
24.00	15.157	+/- 0.242
25.00	15.371	+/- 0.219
26.00	15.077	+/- 0.219
26.50	14.732	+/- 0.258

Copy Data to SNS This option is only available if the DUT is an Agilent N400xA series noise source and the DUT measurement is complete. The process is explained in “Copying Data to SNS” on page 85.

Return Returns you to the ENR Measurement display.

To return to “The ENR Measurement Procedure” on page 60, click the pdf hot-link.

Copying Data to SNS

Figure 5-17 shows a warning message displayed after clicking **Copy Data to SNS**, click **OK** if you want to continue.

Figure 5-17

Warning Message for SNS Erased Data

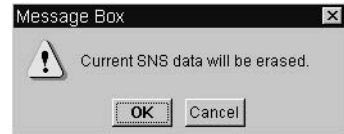

The Agilent N400xA SNS's have ENR and reflection coefficient data values stored in their EEPROM. New data can be written to the SNS when an ENR measurement has been completed. The data written to the SNS consists of the ENR result, the ENR measurement uncertainty result and the reflection coefficient measurement result data.

There are two options for the reflection coefficient measurement result data. The **Copy Data to SNS** function shows the Figure 5-18 display.

Figure 5-18

Saving SNS Result Data

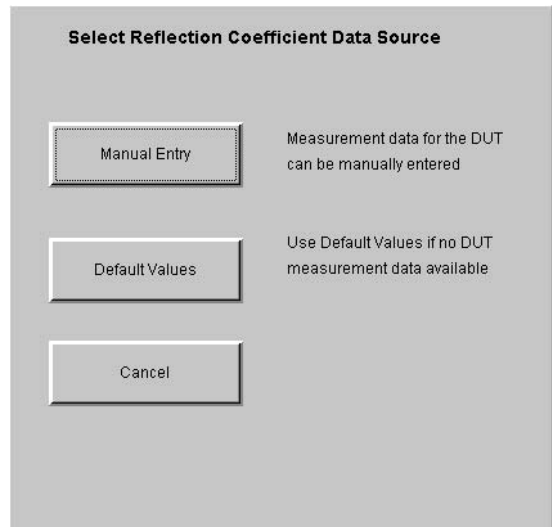

NOTE

On an SNS, Reflection Coefficient data must be entered.

The options available to choose from are:

Manual Entry

The results for reflection coefficient magnitude and phase must be entered manually. Figure 5-19 shows a typical window allowing you to enter the Reflection Magnitude Values for the DUT Off condition. You are presented with three other windows, namely Reflection Magnitude Values for the DUT On, Reflection Phase Values for the DUT Off, and Reflection Phase Values for the DUT On.

Figure 5-19

Manual VSWR Entry Window

The screenshot shows a dialog box titled "Enter reflection magnitude values for the DUT OFF". It contains a grid of 24 input fields, each labeled with a frequency: 0.01 GHz, 0.10 GHz, 1.00 GHz, 2.00 GHz, 3.00 GHz, 4.00 GHz, 5.00 GHz, 6.00 GHz, 7.00 GHz, 8.00 GHz, 9.00 GHz, 10.0 GHz, 11.0 GHz, 12.0 GHz, 13.0 GHz, 14.0 GHz, 15.0 GHz, 16.0 GHz, 17.0 GHz, 18.0 GHz, 19.0 GHz, 20.0 GHz, 21.0 GHz, 22.0 GHz, 23.0 GHz, 24.0 GHz, 25.0 GHz, 26.0 GHz, 26.5 GHz, and 18.0 GHz. Each input field contains the number "0". At the bottom of the dialog are two buttons: "OK" and "Cancel".

Default Values

If no reflection coefficient measurement data is available for the DUT, default values are used. This option uses the ENR measurement results but all reflection coefficient measurement data is set to zero.

Cancel

Returns you to the DUT ENR Measurement display.

To return to "The ENR Measurement Procedure" on page 60, click the pdf hot-link.

Making Multi Measurement on a DUT

DUT Multi Measurement is similar to DUT Measurement, but the measurement can be repeated up to a maximum of twelve times. This allows you, for example, to look for any repeatability effects. Clicking the **DUT Multi Measurement** button on the **Select and Measure DUT** window starts the measurement process. When the final result is obtained a display similar to Figure 5-20 is presented.

The number of required measurement repeats are entered at the start of the measurement, up to a maximum of twelve. A measurement is made on the DUT at the first measurement frequency point. The DUT's ENR results are calculated for the DUT at this frequency point. The ENR measurement result is the only value calculated and the result is displayed with the frequency point the measurement was made at. When the measurement is completed, you are prompted to continue with the next measurement. The previous measurement results are cleared from the display and DUT measurement starts at the first measurement frequency point.

The process is repeated for all measurement frequency points. The display is updated with the DUT's ENR results for one frequency point at a time.

Figure 5-20 ENR Multi Measurement Result Data

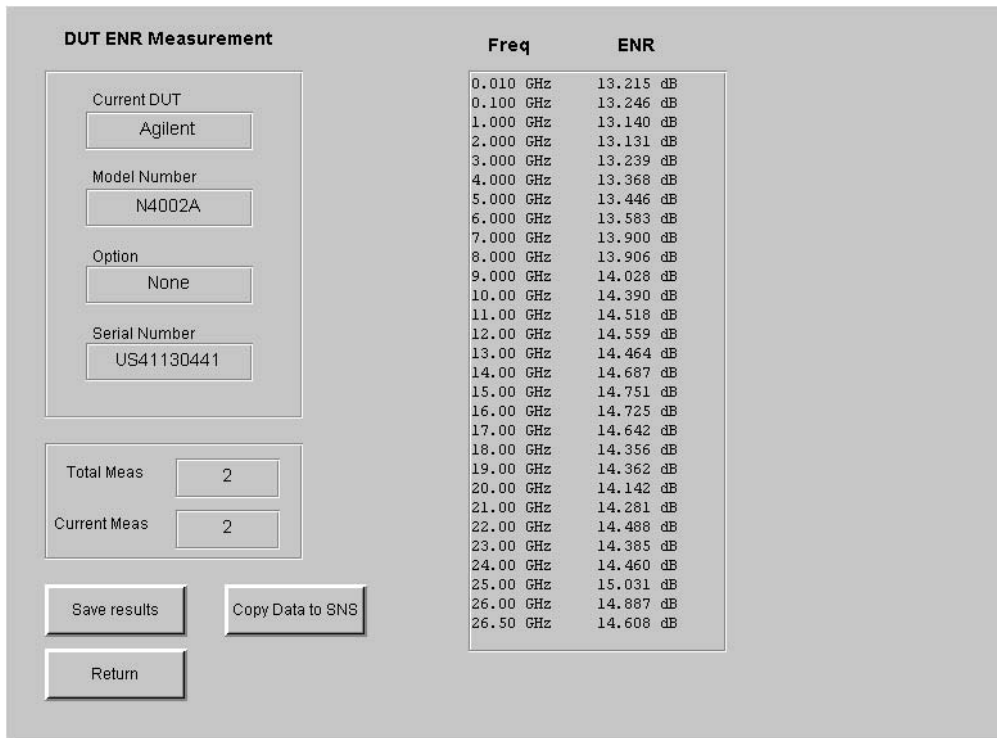

The options available to choose from are:

Save results

Measurement results can be saved as a comma separated values file (.csv) which can then be imported into Microsoft Excel for analysis.

Figure 5-21 is an example of the measurement results data displayed on a spreadsheet.

Figure 5-21

Example of ENR Multi Measurement Result Data as CSVs

	A	B	C	D	E	F	G	H	I	J	K	L	M	N	O
1															
2	Agilent Technologies Noise Source Calibration System														
3	ENR Measurement Results														
4															
5	CSO Number - 233														
6	Engineers Name - Doug														
7	Cal Software Rev No - A.00.00														
8															
9	DUT Manufacturer - Agilent														
10	DUT Type - N4002A														
11	DUT Serial Number - XXXXX														
12															
13	Ref Std Manufacturer - Agilent														
14	Ref Std Type - N4002A														
15	Ref Std Serial Number - Proto D														
16															
17	Test Date - 01.May.2003														
18	Temperature - 23.50 C														
19	Humidity - 50.23 %														
20															
21	Freq	ENR1	ENR2	ENR3	ENR4	ENR5	ENR6	ENR7	ENR8	ENR9	ENR10	Unc	Mean	Std Dev	
22	0.01	13.1311	13.0867	13.2178	13.18506	13.05438	13.03149	13.03596	13.10617	13.19589	13.19954	0.11644	13.12441	0.071734	
23	0.1	13.24273	13.24025	13.2363	13.23583	13.23893	13.24154	13.23565	13.24155	13.23369	13.23058	0.151863	13.23772	0.003913	
24	1	13.15646	13.15516	13.15433	13.15804	13.1573	13.15844	13.15825	13.15389	13.14419	13.14891	0.142444	13.15423	0.005049	
25	2	13.13294	13.13352	13.13123	13.13297	13.12714	13.13511	13.12694	13.12987	13.12242	13.12025	0.131933	13.12925	0.004963	
26	3	13.25814	13.24884	13.25305	13.25593	13.25369	13.25897	13.25412	13.25112	13.24128	13.24426	0.099472	13.25194	0.005733	
27	4	13.38574	13.387	13.39078	13.39992	13.39706	13.40231	13.39056	13.39167	13.38098	13.39006	0.131798	13.39161	0.00655	
28	5	13.48776	13.49561	13.49214	13.49024	13.48983	13.49582	13.48988	13.48996	13.49264	13.48478	0.131798	13.49087	0.003361	
29	6	13.59368	13.58395	13.5848	13.5869	13.58361	13.58664	13.5827	13.58391	13.57918	13.57999	0.100159	13.58354	0.002476	
30	7	13.84673	13.87295	13.87429	13.88341	13.87859	13.87515	13.87128	13.88168	13.84172	13.86354	0.104995	13.86893	0.014208	
31	8	14.06283	14.07184	14.07086	14.07737	14.08004	14.07823	14.06836	14.07055	14.05653	14.06264	0.111036	14.06992	0.00758	
32	9	14.2973	14.31883	14.32923	14.33644	14.33538	14.32713	14.30968	14.31174	14.2817	14.30794	0.124687	14.31554	0.017472	
33	10	14.69263	14.69884	14.70218	14.70476	14.69971	14.70538	14.69807	14.69205	14.68304	14.6904	0.1213	14.69671	0.007073	
34	11	15.1314	15.15354	15.16344	15.16014	15.1598	15.159	15.14624	15.15213	15.11997	15.14823	0.122714	15.14939	0.013901	
35	12	15.0356	15.06023	15.06876	15.06579	15.06913	15.06671	15.0439	15.05878	15.01475	15.04594	0.131159	15.05296	0.017777	
36	13	14.73948	14.79853	14.81755	14.81626	14.81639	14.81029	14.77402	14.80397	14.73216	14.78573	0.139876	14.78944	0.031609	
37	14	14.77904	14.84532	14.8736	14.88208	14.86929	14.8758	14.83187	14.86576	14.74525	14.83277	0.150881	14.84008	0.045391	
38	15	14.41842	14.55971	14.59303	14.60446	14.60389	14.59387	14.51426	14.60073	14.34298	14.5263	0.140379	14.53576	0.089628	
39	16	14.3669	14.4219	14.44611	14.46164	14.44731	14.45556	14.41058	14.45447	14.31557	14.40819	0.145139	14.41882	0.046617	
40	17	14.4393	14.45672	14.46784	14.4628	14.46703	14.45774	14.45093	14.46075	14.42534	14.43445	0.140379	14.45229	0.014455	
41	18	14.4604	14.52024	14.53642	14.53962	14.54265	14.54355	14.50098	14.54031	14.43562	14.48806	0.157052	14.51039	0.038779	
42	19	14.66055	14.69443	14.70891	14.70334	14.70355	14.70333	14.6824	14.69983	14.63502	14.68626	0.226121	14.68776	0.02339	
43	20	14.55214	14.60911	14.63471	14.62847	14.62956	14.63002	14.59335	14.63346	14.52894	14.5957	0.226121	14.60254	0.037292	
44	21	14.83915	14.90736	14.93299	14.91484	14.93206	14.92607	14.88802	14.92543	14.81475	14.89606	0.233732	14.89767	0.040543	
45	22	15.15156	15.24184	15.24046	15.2673	15.26671	15.26291	15.21858	15.26545	15.15283	15.23129	0.226121	15.22989	0.044183	
46	23	15.22989	15.32421	15.32408	15.35984	15.35771	15.35316	15.29142	15.3566	15.20766	15.31226	0.197815	15.31168	0.054168	
47	24	15.21804	15.36442	15.41804	15.4149	15.35118	15.40919	15.33471	15.40838	15.17855	15.35243	0.241518	15.34498	0.083507	
48	25	15.42014	15.45581	15.46138	15.48021	15.45092	15.45711	15.44034	15.45407	15.38307	15.44261	0.218703	15.44255	0.02426	
49	26	15.08592	15.09594	15.0779	15.09051	15.08333	15.07953	15.08751	15.08877	15.0964	15.07771	0.218703	15.08635	0.006826	
50	26.5	14.75287	14.75225	14.7545	14.75079	14.75371	14.75688	14.75218	14.7477	14.74314	14.74634	0.257548	14.75122	0.003933	
51															

Copy data to SNS

Data can be copied to an SNS DUT, but it must be entered manually.

Return

Returns you to the ENR Measurement display.

To return to “The ENR Measurement Procedure” on page 60, click the pdf hot-link.

Selecting Other

The Other option covers all other manufacturer's noise sources or Agilent noise sources operating at frequencies other than the standard cardinal values. The number of data points is controlled by the number of Frequency/ENR pairs in the NFA. Before performing a measurement using reference standard of type **Other**, an ENR table containing the measurement frequencies and ENR values to be used must be created in the NFA.

The display contains one field for each measurement frequency. The ENR measurement uncertainty for the reference standard must be entered manually for each frequency point. The interpolated values are also calculated manually.

Selecting **Other** as the DUT type produces the display similar to Figure 5-22.

NOTE

The NFA can only store a maximum of 81 Frequency/ENR pairs.

NOTE

Any DUT can be measured using any reference standard. However, measurement is limited to 18.0 GHz if the reference standard, or DUT, is an Agilent 346A, 346B, N4000A, or N4001A.

Figure 5-22 Typical Other Display

The screenshot shows a dialog box titled "Enter the following details for the Reference Standard". It contains four input fields arranged in a 2x2 grid. The top-left field is labeled "Manufacturer" and contains the text "Agilent". The top-right field is labeled "Model Number" and contains the text "Other". The bottom-left field is labeled "Option" and contains the text "None". The bottom-right field is labeled "Serial Number" and contains the text "12345678". At the bottom of the dialog, there are two buttons: "OK" on the left and "Cancel" on the right.

The data is entered manually in these fields. The data required is:

Manufacturer The DUT manufacturer.

Model Number The DUT model number.

Option Any DUT options.

Serial Number The DUT serial number.

Clicking the **OK** button accepts the data that has been entered. Clicking the **Cancel** button ignores the changes and returns you to the **ENR Measurement** display.

Figure 5-23 is a typical display of the Reference Standard's **ENR Uncertainty Values**.

Figure 5-23 Enter Uncertainty Values for Other

Enter Reference Standard ENR Uncertainty Values

0.000
0.000
0.000
0.000
0.000
0.000
0.000
0.000
0.000
0.000
0.000
0.000
0.000
0.000
0.000
0.000
0.000
0.000
0.000
0.000
0.000
0.000

Current Standard
Agilent

Model Number
Other

Option
12345678

Serial Number
None

OK Reset Values Cancel

Setting SNS Bias Current

When repairing an SNS, certain replacement parts are supplied with a value of bias current. This information should be programmed to make the SNS work correctly.

CAUTION

Performing a SNS Bias Current setting wrongly can make your SNS inoperable. Agilent Technologies recommend this is only performed by trained operators. If you attempt to do this a warning is displayed similar to Figure 5-24.

Figure 5-24 SNS Bias Current Warning

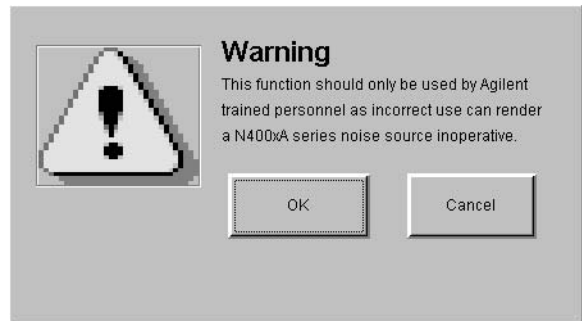

Selecting **OK** displays a window similar to Figure 5-25.

Select the SNS type you want to set the bias current on and enter the value of bias current supplied with the new assembly in the Enter Supplied Current Value field.

Figure 5-25

SNS Bias Current Source Selection

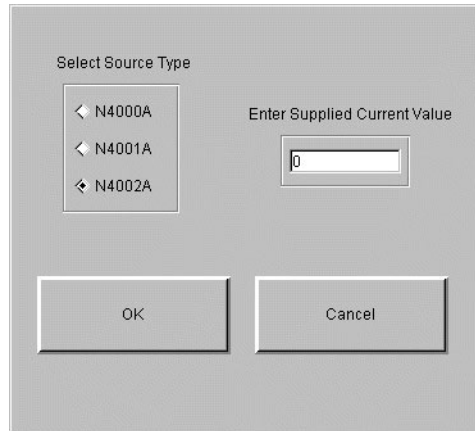

After the SNS Bias Current setting is complete, you need to measure the SNS to confirm the ENR values are within the published specifications.

Test Records for the 346A
Reflection Coefficient Magnitude and Phase Test Record

**Reflection Coefficient Magnitude and Phase
 Test Record**

Frequency Range (MHz)	Freq. (MHz)	Source OFF Reflection Coefficient		Source ON Reflection Coefficient		Spec.	Pass /Fail
		Magnitude	Phase	Magnitude	Phase		
10.0 to 30.0						≤ 0.13	
30.0 to 3000.0						≤ 0.07	
3000.0 to 5000.0						≤ 0.07	
5000.0 to 18000.0						≤ 0.11	
	10.0					≤ 0.13	
	100.0					≤ 0.07	
	1000.0					≤ 0.07	
	2000.0					≤ 0.07	
	3000.0					≤ 0.07	
	4000.0					≤ 0.07	
	5000.0					≤ 0.07	
	6000.0					≤ 0.11	
	7000.0					≤ 0.11	
	8000.0					≤ 0.11	
	9000.0					≤ 0.11	
	10000.0					≤ 0.11	
	11000.0					≤ 0.11	

Test Records for the 346A

Reflection Coefficient Magnitude and Phase Test Record

Frequency Range (MHz)	Freq. (MHz)	Source OFF Reflection Coefficient		Source ON Reflection Coefficient		Spec.	Pass /Fail
		Magnitude	Phase	Magnitude	Phase		
	12000.0					≤ 0.11	
	13000.0					≤ 0.11	
	14000.0					≤ 0.11	
	15000.0					≤ 0.11	
	16000.0					≤ 0.11	
	17000.0					≤ 0.11	
	18000.0					≤ 0.11	

Test Records for the 346A
Excess Noise Ratio (ENR) Test Record

Excess Noise Ratio (ENR) Test Record

Frequency (MHz)	Standard ENR ₁ (dB)	Standard Y ₁ (Lin)	DUT Y ₂ (Lin)	DUT ENR ₂ (dB)
10.0				
100.0				
1000.0				
2000.0				
3000.0				
4000.0				
5000.0				
6000.0				
7000.0				
8000.0				
9000.0				
10000.0				
11000.0				
12000.0				
13000.0				
14000.0				
15000.0				
16000.0				
17000.0				
18000.0				

Uncertainty Test Record

Frequency (MHz)	(U_{cENR_1}) Standard ENR ₁ Uncertainty (dB)	(U_{cSys}) System Uncertainty (dB)	(U_{cENR_2}) DUT ENR ₂ Uncertainty (dB)
10.0		0.0785	
100.0		0.0785	
1000.0		0.0905	
2000.0		0.0905	
3000.0		0.0726	
4000.0		0.0726	
5000.0		0.0726	
6000.0		0.0726	
7000.0		0.0800	
8000.0		0.0800	
9000.0		0.1076	
10000.0		0.1076	
11000.0		0.1076	
12000.0		0.1076	
13000.0		0.1211	
14000.0		0.1211	
15000.0		0.1211	
16000.0		0.1211	
17000.0		0.1211	
18000.0		0.1211	

Test Records for the 346A
Uncertainty Test Record

B **Test Records for the 346B**

This appendix provides test records for you to photocopy and use when performing each calibration and verification test. As the reflection coefficient and phase test use two VNAs, the test records are provided with a convenient break point at 3.0 GHz.

Test Records for the 346B
Reflection Coefficient Magnitude and Phase Test Record

**Reflection Coefficient Magnitude and Phase
 Test Record**

Frequency Range (MHz)	Freq. (MHz)	Source OFF Reflection Coefficient		Source ON Reflection Coefficient		Spec.	Pass /Fail
		Magnitude	Phase	Magnitude	Phase		
10.0 to 30.0						≤ 0.13	
30.0 to 3000.0						≤ 0.07	
3000.0 to 5000.0						≤ 0.07	
5000.0 to 18000.0						≤ 0.11	
	10.0					≤ 0.13	
	100.0					≤ 0.07	
	1000.0					≤ 0.07	
	2000.0					≤ 0.07	
	3000.0					≤ 0.07	
	4000.0					≤ 0.07	
	5000.0					≤ 0.07	
	6000.0					≤ 0.11	
	7000.0					≤ 0.11	
	8000.0					≤ 0.11	
	9000.0					≤ 0.11	
	10000.0					≤ 0.11	
	11000.0					≤ 0.11	

Test Records for the 346B
Reflection Coefficient Magnitude and Phase Test Record

Frequency Range (MHz)	Freq. (MHz)	Source OFF Reflection Coefficient		Source ON Reflection Coefficient		Spec.	Pass /Fail
		Magnitude	Phase	Magnitude	Phase		
	12000.0					≤ 0.11	
	13000.0					≤ 0.11	
	14000.0					≤ 0.11	
	15000.0					≤ 0.11	
	16000.0					≤ 0.11	
	17000.0					≤ 0.11	
	18000.0					≤ 0.11	

Test Records for the 346B
Excess Noise Ratio (ENR) Test Record

Excess Noise Ratio (ENR) Test Record

Frequency (MHz)	Standard ENR ₁ (dB)	Standard Y ₁ (Lin)	DUT Y ₂ (Lin)	DUT ENR ₂ (dB)
10.0				
100.0				
1000.0				
2000.0				
3000.0				
4000.0				
5000.0				
6000.0				
7000.0				
8000.0				
9000.0				
10000.0				
11000.0				
12000.0				
13000.0				
14000.0				
15000.0				
16000.0				
17000.0				
18000.0				

Uncertainty Test Record

Frequency (MHz)	(U _c ENR ₁) Standard ENR ₁ Uncertainty (dB)	(U _c Sys) System Uncertainty (dB)	(U _c ENR ₂) DUT ENR ₂ Uncertainty (dB)
10.0		0.0785	
100.0		0.0785	
1000.0		0.0905	
2000.0		0.0905	
3000.0		0.0726	
4000.0		0.0726	
5000.0		0.0726	
6000.0		0.0726	
7000.0		0.0800	
8000.0		0.0800	
9000.0		0.1076	
10000.0		0.1076	
11000.0		0.1076	
12000.0		0.1076	
13000.0		0.1211	
14000.0		0.1211	
15000.0		0.1211	
16000.0		0.1211	
17000.0		0.1211	
18000.0		0.1211	

Test Records for the 346B
Uncertainty Test Record

C **Test Records for the 346C**

This appendix provides test records for you to photocopy and use when performing each calibration and verification test. As the reflection coefficient and phase test use two VNAs, the test records are provided with a convenient break point at 3.0 GHz.

Test Records for the 346C
Reflection Coefficient Magnitude and Phase Test Record

**Reflection Coefficient Magnitude and Phase
 Test Record**

Frequency Range (MHz)	Freq. (MHz)	Source OFF Reflection Coefficient		Source ON Reflection Coefficient		Spec.	Pass /Fail
		Magnitude	Phase	Magnitude	Phase		
10.0 to 3000.0						≤ 0.11	
3000.0 to 18000.0						≤ 0.11	
18000.0 to 26500.0						≤ 0.15	
	10.0					≤ 0.11	
	100.0					≤ 0.11	
	1000.0					≤ 0.11	
	2000.0					≤ 0.11	
	3000.0					≤ 0.11	
	4000.0					≤ 0.11	
	5000.0					≤ 0.11	
	6000.0					≤ 0.11	
	7000.0					≤ 0.11	
	8000.0					≤ 0.11	
	9000.0					≤ 0.11	
	10000.0					≤ 0.11	
	11000.0					≤ 0.11	
	12000.0					≤ 0.11	

Test Records for the 346C
Reflection Coefficient Magnitude and Phase Test Record

Frequency Range (MHz)	Freq. (MHz)	Source OFF Reflection Coefficient		Source ON Reflection Coefficient		Spec.	Pass /Fail
		Magnitude	Phase	Magnitude	Phase		
	13000.0					≤ 0.11	
	14000.0					≤ 0.11	
	15000.0					≤ 0.11	
	16000.0					≤ 0.11	
	17000.0					≤ 0.11	
	18000.0					≤ 0.11	
	19000.0					≤ 0.15	
	20000.0					≤ 0.15	
	21000.0					≤ 0.15	
	22000.0					≤ 0.15	
	23000.0					≤ 0.15	
	24000.0					≤ 0.15	
	25000.0					≤ 0.15	
	26000.0					≤ 0.15	
	26500.0					≤ 0.15	

Test Records for the 346C
Excess Noise Ratio (ENR) Test Record

Excess Noise Ratio (ENR) Test Record

Frequency (MHz)	Standard ENR ₁ (dB)	Standard Y ₁ (Lin)	DUT Y ₂ (Lin)	DUT ENR ₂ (dB)
10.0				
100.0				
1000.0				
2000.0				
3000.0				
4000.0				
5000.0				
6000.0				
7000.0				
8000.0				
9000.0				
10000.0				
11000.0				
12000.0				
13000.0				
14000.0				
15000.0				
16000.0				
17000.0				
18000.0				
19000.0				

Test Records for the 346C
Excess Noise Ratio (ENR) Test Record

Frequency (MHz)	Standard ENR₁ (dB)	Standard Y₁ (Lin)	DUT Y₂ (Lin)	DUT ENR₂ (dB)
20000.0				
21000.0				
22000.0				
23000.0				
24000.0				
25000.0				
26000.0				
26500.0				

Test Records for the 346C
Uncertainty Test Record

Uncertainty Test Record

Frequency (MHz)	(U_{cENR_1}) Standard ENR ₁ Uncertainty (dB)	(U_{cSys}) System Uncertainty (dB)	(U_{cENR_2}) DUT ENR ₂ Uncertainty (dB)
10.0		0.0785	
100.0		0.0785	
1000.0		0.0905	
2000.0		0.0905	
3000.0		0.0726	
4000.0		0.0726	
5000.0		0.0726	
6000.0		0.0726	
7000.0		0.0800	
8000.0		0.0800	
9000.0		0.1076	
10000.0		0.1076	
11000.0		0.1076	
12000.0		0.1076	
13000.0		0.1211	
14000.0		0.1211	
15000.0		0.1211	
16000.0		0.1211	
17000.0		0.1211	
18000.0		0.1211	

Frequency (MHz)	(U_{cENR_1}) Standard ENR₁ Uncertainty (dB)	(U_{cSys}) System Uncertainty (dB)	(U_{cENR_2}) DUT ENR₂ Uncertainty (dB)
19000.0		0.1491	
20000.0		0.1491	
21000.0		0.1491	
22000.0		0.1491	
23000.0		0.1491	
24000.0		0.1491	
25000.0		0.1491	
26000.0		0.1491	
26500.0		0.1491	

Test Records for the 346C
Uncertainty Test Record

D **Test Records for the N4000A**

This appendix provides test records for you to photocopy and use when performing each calibration and verification test. As the reflection coefficient and phase test use two VNAs, the test records are provided with a convenient break point at 3.0 GHz.

Test Records for the N4000A
Reflection Coefficient Magnitude and Phase Test Record

**Reflection Coefficient Magnitude and Phase
 Test Record**

Frequency Range (MHz)	Freq. (MHz)	Source OFF Reflection Coefficient		Source ON Reflection Coefficient		Spec.	Pass /Fail
		Magnitude	Phase	Magnitude	Phase		
10.0 to 1500.0						≤ 0.02	
1500.0 to 3000.0						≤ 0.02	
3000.0 to 7000.0						≤ 0.06	
7000.0 to 18000.0						≤ 0.10	
	10.0					≤ 0.02	
	100.0					≤ 0.02	
	1000.0					≤ 0.02	
	2000.0					≤ 0.02	
	3000.0					≤ 0.02	
	4000.0					≤ 0.06	
	5000.0					≤ 0.06	
	6000.0					≤ 0.06	
	7000.0					≤ 0.06	
	8000.0					≤ 0.10	
	9000.0					≤ 0.10	
	10000.0					≤ 0.10	
	11000.0					≤ 0.10	

Test Records for the N4000A
Reflection Coefficient Magnitude and Phase Test Record

Frequency Range (MHz)	Freq. (MHz)	Source OFF Reflection Coefficient		Source ON Reflection Coefficient		Spec.	Pass /Fail
		Magnitude	Phase	Magnitude	Phase		
	12000.0					≤ 0.10	
	13000.0					≤ 0.10	
	14000.0					≤ 0.10	
	15000.0					≤ 0.10	
	16000.0					≤ 0.10	
	17000.0					≤ 0.10	
	18000.0					≤ 0.10	

Test Records for the N4000A
Excess Noise Ratio (ENR) Test Record

Excess Noise Ratio (ENR) Test Record

Frequency (MHz)	Standard ENR ₁ (dB)	Standard Y ₁ (Lin)	DUT Y ₂ (Lin)	DUT ENR ₂ (dB)
10.0				
100.0				
1000.0				
2000.0				
3000.0				
4000.0				
5000.0				
6000.0				
7000.0				
8000.0				
9000.0				
10000.0				
11000.0				
12000.0				
13000.0				
14000.0				
15000.0				
16000.0				
17000.0				
18000.0				

Uncertainty Test Record

Frequency (MHz)	(U _c ENR ₁) Standard ENR ₁ Uncertainty (dB)	(U _c Sys) System Uncertainty (dB)	(U _c ENR ₂) DUT ENR ₂ Uncertainty (dB)
10.0		0.0785	
100.0		0.0785	
1000.0		0.0905	
2000.0		0.0905	
3000.0		0.0726	
4000.0		0.0726	
5000.0		0.0726	
6000.0		0.0726	
7000.0		0.0800	
8000.0		0.0800	
9000.0		0.1076	
10000.0		0.1076	
11000.0		0.1076	
12000.0		0.1076	
13000.0		0.1211	
14000.0		0.1211	
15000.0		0.1211	
16000.0		0.1211	
17000.0		0.1211	
18000.0		0.1211	

Test Records for the N4000A
Uncertainty Test Record

Test Records for the N4001A
Reflection Coefficient Magnitude and Phase Test Record

**Reflection Coefficient Magnitude and Phase
 Test Record**

Frequency Range (MHz)	Freq. (MHz)	Source OFF Reflection Coefficient		Source ON Reflection Coefficient		Spec.	Pass /Fail
		Magnitude	Phase	Magnitude	Phase		
10.0 to 1500.0						≤ 0.07	
1500.0 to 3000.0						≤ 0.07	
3000.0 to 7000.0						≤ 0.09	
7000.0 to 18000.0						≤ 0.11	
	10.0					≤ 0.07	
	100.0					≤ 0.07	
	1000.0					≤ 0.07	
	2000.0					≤ 0.07	
	3000.0					≤ 0.07	
	4000.0					≤ 0.09	
	5000.0					≤ 0.09	
	6000.0					≤ 0.09	
	7000.0					≤ 0.09	
	8000.0					≤ 0.11	
	9000.0					≤ 0.11	
	10000.0					≤ 0.11	
	11000.0					≤ 0.11	

Test Records for the N4001A
Reflection Coefficient Magnitude and Phase Test Record

Frequency Range (MHz)	Freq. (MHz)	Source OFF Reflection Coefficient		Source ON Reflection Coefficient		Spec.	Pass /Fail
		Magnitude	Phase	Magnitude	Phase		
	12000.0					≤ 0.11	
	13000.0					≤ 0.11	
	14000.0					≤ 0.11	
	15000.0					≤ 0.11	
	16000.0					≤ 0.11	
	17000.0					≤ 0.11	
	18000.0					≤ 0.11	

Test Records for the N4001A
Excess Noise Ratio (ENR) Test Record

Excess Noise Ratio (ENR) Test Record

Frequency (MHz)	Standard ENR ₁ (dB)	Standard Y ₁ (Lin)	DUT Y ₂ (Lin)	DUT ENR ₂ (dB)
10.0				
100.0				
1000.0				
2000.0				
3000.0				
4000.0				
5000.0				
6000.0				
7000.0				
8000.0				
9000.0				
10000.0				
11000.0				
12000.0				
13000.0				
14000.0				
15000.0				
16000.0				
17000.0				
18000.0				

Uncertainty Test Record

Frequency (MHz)	(U_{cENR_1}) Standard ENR ₁ Uncertainty (dB)	(U_{cSys}) System Uncertainty (dB)	(U_{cENR_2}) DUT ENR ₂ Uncertainty (dB)
10.0		0.0785	
100.0		0.0785	
1000.0		0.0905	
2000.0		0.0905	
3000.0		0.0726	
4000.0		0.0726	
5000.0		0.0726	
6000.0		0.0726	
7000.0		0.0800	
8000.0		0.0800	
9000.0		0.1076	
10000.0		0.1076	
11000.0		0.1076	
12000.0		0.1076	
13000.0		0.1211	
14000.0		0.1211	
15000.0		0.1211	
16000.0		0.1211	
17000.0		0.1211	
18000.0		0.1211	

Test Records for the N4001A
Uncertainty Test Record

F **Test Records for the N4002A**

This appendix provides test records for you to photocopy and use when performing each calibration and verification test. As the reflection coefficient and phase test use two VNAs, the test records are provided with a convenient break point at 3.0 GHz.

Test Records for the N4002A
Reflection Coefficient Magnitude and Phase Test Record

**Reflection Coefficient Magnitude and Phase
 Test Record**

Frequency Range (MHz)	Freq. (MHz)	Source OFF Reflection Coefficient		Source ON Reflection Coefficient		Spec.	Pass /Fail
		Magnitude	Phase	Magnitude	Phase		
10.0 to 1500.0						≤ 0.10	
1500.0 to 3000.0						≤ 0.10	
3000.0 to 7000.0						≤ 0.10	
7000.0 to 18000.0						≤ 0.11	
18000.0 to 26500.0						≤ 0.15	
	10.0					≤ 0.10	
	100.0					≤ 0.10	
	1000.0					≤ 0.10	
	2000.0					≤ 0.10	
	3000.0					≤ 0.10	
	4000.0					≤ 0.10	
	5000.0					≤ 0.10	
	6000.0					≤ 0.10	
	7000.0					≤ 0.10	
	8000.0					≤ 0.11	
	9000.0					≤ 0.11	

Test Records for the N4002A
Reflection Coefficient Magnitude and Phase Test Record

Frequency Range (MHz)	Freq. (MHz)	Source OFF Reflection Coefficient		Source ON Reflection Coefficient		Spec.	Pass /Fail
		Magnitude	Phase	Magnitude	Phase		
	10000.0					≤ 0.11	
	11000.0					≤ 0.11	
	12000.0					≤ 0.11	
	13000.0					≤ 0.11	
	14000.0					≤ 0.11	
	15000.0					≤ 0.11	
	16000.0					≤ 0.11	
	17000.0					≤ 0.11	
	18000.0					≤ 0.11	
	19000.0					≤ 0.15	
	20000.0					≤ 0.15	
	21000.0					≤ 0.15	
	22000.0					≤ 0.15	
	23000.0					≤ 0.15	
	24000.0					≤ 0.15	
	25000.0					≤ 0.15	
	26000.0					≤ 0.15	
	26500.0					≤ 0.15	

Test Records for the N4002A
Excess Noise Ratio (ENR) Test Record

Excess Noise Ratio (ENR) Test Record

Frequency (MHz)	Standard ENR ₁ (dB)	Standard Y ₁ (Lin)	DUT Y ₂ (Lin)	DUT ENR ₂ (dB)
10.0				
100.0				
1000.0				
2000.0				
3000.0				
4000.0				
5000.0				
6000.0				
7000.0				
8000.0				
9000.0				
10000.0				
11000.0				
12000.0				
13000.0				
14000.0				
15000.0				
16000.0				
17000.0				
18000.0				
19000.0				

Test Records for the N4002A
Excess Noise Ratio (ENR) Test Record

Frequency (MHz)	Standard ENR ₁ (dB)	Standard Y ₁ (Lin)	DUT Y ₂ (Lin)	DUT ENR ₂ (dB)
20000.0				
21000.0				
22000.0				
23000.0				
24000.0				
25000.0				
26000.0				
26500.0				

Test Records for the N4002A
Uncertainty Test Record

Uncertainty Test Record

Frequency (MHz)	(U_{cENR_1}) Standard ENR ₁ Uncertainty (dB)	(U_{cSys}) System Uncertainty (dB)	(U_{cENR_2}) DUT ENR ₂ Uncertainty (dB)
10.0		0.0785	
100.0		0.0785	
1000.0		0.0905	
2000.0		0.0905	
3000.0		0.0726	
4000.0		0.0726	
5000.0		0.0726	
6000.0		0.0726	
7000.0		0.0800	
8000.0		0.0800	
9000.0		0.1076	
10000.0		0.1076	
11000.0		0.1076	
12000.0		0.1076	
13000.0		0.1211	
14000.0		0.1211	
15000.0		0.1211	
16000.0		0.1211	
17000.0		0.1211	
18000.0		0.1211	

Test Records for the N4002A
Uncertainty Test Record

Frequency (MHz)	(U_{cENR_1}) Standard ENR₁ Uncertainty (dB)	(U_{cSys}) System Uncertainty (dB)	(U_{cENR_2}) DUT ENR₂ Uncertainty (dB)
19000.0		0.1491	
20000.0		0.1491	
21000.0		0.1491	
22000.0		0.1491	
23000.0		0.1491	
24000.0		0.1491	
25000.0		0.1491	
26000.0		0.1491	
26500.0		0.1491	

Test Records for the N4002A
Uncertainty Test Record

G **Caring for Connectors**

The material contained in this appendix may not be apply to the connector you are using on the instrument.

Introduction

Recent advances in measurement capabilities have made connectors and connection techniques more important than ever before. Damage to the connectors on calibration and verification devices, test ports, cables, and other devices represent an increasing burden in downtime and expense.

This Appendix will help you get the best performance from all coaxial microwave connectors:

- To know what to look for when cleaning and inspecting them, in order to preserve their precision and extend their life.
- To make the best possible microwave connections, improving the accuracy and repeatability of all of your measurements, saving both time and money.

Connector Part Numbers

Refer to the latest edition of the HP RF & Microwave Test Accessories Catalog for connector part numbers.

Handling and Storage

Microwave connectors must be handled carefully, inspected before use and when not in use, stored in a way that gives them maximum protection. Avoid touching the connector mating plane surfaces and avoid setting the connectors contact-end down, especially on a hard surface.

Never store connectors with the contact end exposed. Plastic end caps are provided with all Agilent connectors and these should be retained after unpacking and placed over the ends of the connectors whenever they are not in use. Extend the threads of connectors that have a retractable sleeve or sliding connector nut, then put the plastic end cap over the end of the connector.

Above all, never store any devices loose in a box or in a desk or a bench drawer. Careless handling of this kind is the most common cause of connector damage during storage.

Visual Inspection

Visual inspection and, if necessary, cleaning should be done every time a connection is made.

Metal and metal by-product particles from the connector threads often find their way onto the mating plane surfaces when a connection is disconnected and even one connection made with a dirty or damaged connector can damage both connectors beyond repair.

Magnification is helpful when inspecting connectors, but it is not required and may actually be misleading. Defects and damage that cannot be seen without magnification generally have no effect on electrical or mechanical performance. Magnification is of great use in analyzing the nature and cause of damage and in cleaning connectors, but it is not required for inspection.

Obvious Defects and Damage

Examine the connectors first for obvious defects or damage: badly worn plating, deformed threads or bent, broken, or misaligned center conductors. Connector nuts should move smoothly and be free of burrs, loose metal particles, and rough spots.

Immediately discard, or mark for identification and send away for repair, any connector that has obvious defects like these.

Mating Plane Surfaces

Flat contact between the connectors at all points on their mating plane surfaces is required for a good connection. Therefore, particular attention should be paid to deep scratches or dents, and to dirt and metal or metal by-product particles on the connector mating plane surfaces.

Also look for bent or rounded edges on the mating plane surfaces of the center and outer conductors and for any signs of damage due to excessive or uneven wear or misalignment.

Visual Inspection

Light burnishing of the mating plane surfaces is normal, and is evident as light scratches or shallow circular marks distributed more or less uniformly over the mating plane surface. Other small defects and cosmetic imperfections are also normal. None of these affect electrical or mechanical performance.

If a connector shows deep scratches or dents, particles clinging to the mating plane surfaces, or uneven wear, clean it and inspect it again. Damage or defects like dents or scratches, which are deep enough to displace metal on the mating plane surface of the connector, may indicate that the connector itself is damaged and should not be used. Try to determine the cause of the damage before making further connections.

Precision 7 mm Connectors

Precision 7mm connectors, among them APC-7[®] connectors, should be inspected visually with the center conductor collets in place, and whenever the collet has been removed. See Figure G-1.

The collet itself should be inspected for edge or surface damage and for any signs that the spring contacts are bent or twisted. If they are, replace the collet. When the collet has been re-inserted, verify that it springs back immediately when pressed with a blunt plastic rod or with the rounded plastic handle of the collet removing tool. Never use a pencil or your finger for this purpose.

Figure G-1

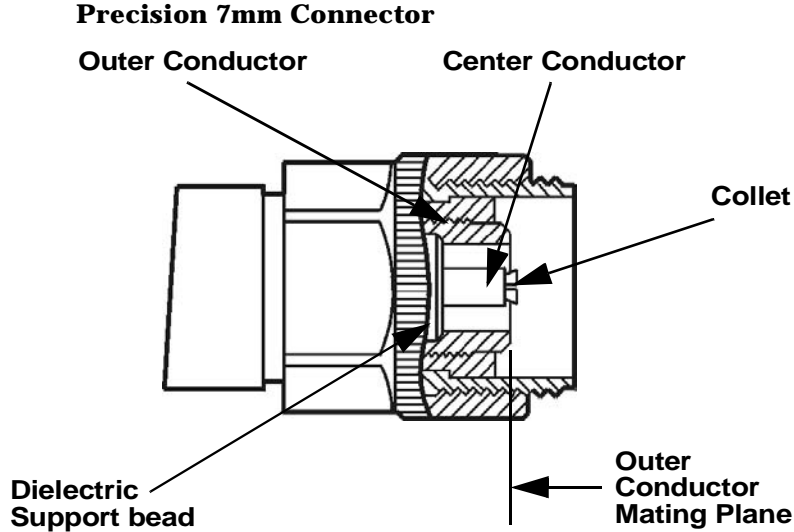

Sexed Connectors

On sexed connectors, especially precision 3.5mm and SMA connectors, pay special attention to the female center conductor contact fingers (Figure G-2 and Figure G-3). These are very easily bent or broken, and damage to them is not always easy to see. Any connector with damaged contact fingers will not make good electrical contact and must be replaced.

Figure G-2

Precision 3.5mm connectors

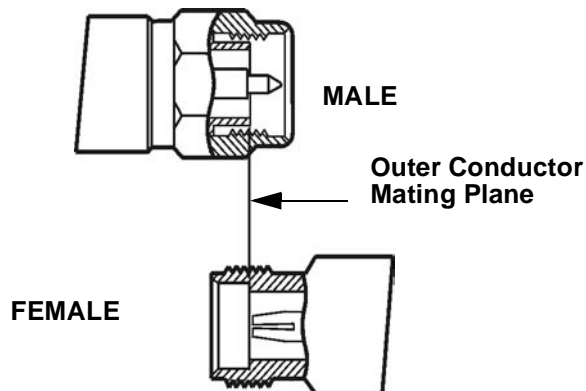
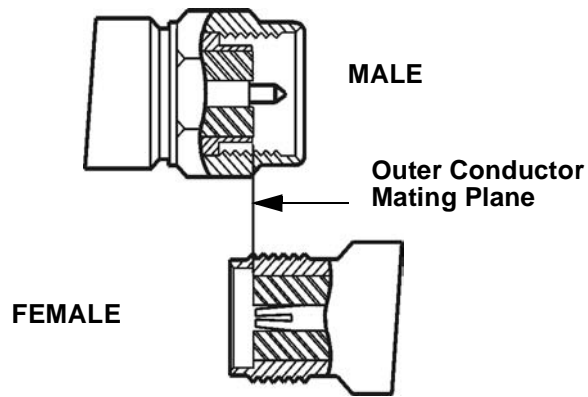

Figure G-3

SMA connectors



Cleaning

Careful cleaning of all connectors is essential to assure long, reliable connector life, to prevent accidental damage to connectors, and to obtain maximum measurement accuracy and repeatability. Yet it is the one step most often neglected or done improperly. Supplies recommended for cleaning microwave connectors are as follows:

- Compressed Air.
- Alcohol.
- Cotton Swabs.
- Lint-Free Cleaning Cloth.

Compressed Air

Loose particles on the connector mating plane surfaces can usually be removed with a quick blast of compressed air. This is very easy to do and should always be tried first using compressed air from a small pressurized can. The stream of air can be directed exactly where it is wanted through a plastic (not metal) nozzle. No hoses or other connections are needed. Hold the can upright, to avoid spraying liquid along with the vapor.

Cleaning Alcohol

Dirt and stubborn contaminants that cannot be removed with compressed air can often be removed with a cotton swab or lint free cleaning cloth moistened with alcohol.

NOTE

Use the least amount of alcohol possible, and avoid wetting any plastic parts in the connectors with the alcohol.

Cleaning

Alcohol should be used in liquid rather than spray form. If a spray must be used, always spray the alcohol onto a cloth or swab, never directly into a connector.

Very dirty connectors can be cleaned with pure alcohol. Other solutions that contain additives should not be used.

Carefully avoid wetting the plastic support bead (which is easily damaged by alcohol) inside the connector and blow the connector dry immediately with a gentle stream of compressed air.

Precision 7 mm Connectors

When precision 7mm connectors have been cleaned with the center conductor collet removed, insert the collet and clean the mating plane surfaces again.

When the connector is attached to a small component, or to a cable, calibration, or verification standard, the easiest way to do this is to put a lint-free cleaning cloth flat on a table and put a couple of drops of alcohol in the center of the cloth. It should be noted that it is not necessary to remove the collet to use this cleaning method.

Retract the connector sleeve threads so that the connector interface is exposed. Gently press the contact end of the connector into the cloth moistened with alcohol, then turn the connector.

Dirt on the connector interface will be scrubbed away by the cloth without damaging the connector. Blow the connector dry with a gentle stream of compressed air.

This cleaning method can be adapted even for fixed connectors such as those attached to test ports. Simply fold the cloth into several layers of thickness, moisten it, press it against the connector interface, and turn it to clean the connector. Blow the connector dry with a gentle stream of compressed air.

Cleaning Interior Surfaces

Interior surfaces, especially on precision 3.5mm connectors, are very difficult to reach, and it is easy to damage connectors in trying to clean them. The openings are very small, and generally the center conductor is supported only at the inner end, by a plastic dielectric support bead. This makes it very easy to bend or break the center conductor.

One suitable method (Figure G-4) is to cut off the sharp tip of a round wooden toothpick, or a smaller diameter wooden rod, and then to wrap it with a single layer of lint-free cleaning cloth.

Figure G-4 **Cleaning interior surfaces**



NOTE

Metal must never be used (it will scratch the plated surfaces), and in cleaning precision 3.5mm connectors the diameter must not exceed 0.070 in. (1.7 mm). The wooden handle of a cotton swab, for example, is too large for this purpose. Even though the handle can sometimes be inserted into the connector, even when wrapped in lint-free cloth, movement of the handle against the center conductor can exert enough force on the center conductor to damage it severely.

Cleaning

Moisten the cloth with a small amount of alcohol and carefully insert it into the connector to clean the interior surfaces. Use an illuminated magnifying glass or microscope to see clearly the areas you wish to clean.

Drying Connectors

When you have cleaned a connector, always be sure that it is completely dry before reassembling or using it. Blow the connector dry with a gentle stream of clean compressed air and inspect it again under a magnifying glass to be sure that no particles or alcohol residues remain.

Mechanical Inspection: Connector Gages

Even a perfectly clean, unused connector can cause problems if it is mechanically out of specification. Since the critical tolerances in microwave connectors are on the order of a few ten-thousandths of an inch, using a connector gage is essential.

Before using any connector for the first time, inspect it mechanically using a connector gage. How often connectors should be gaged after that depends upon usage.

In general, connectors should be gaged whenever visual inspection or electrical performance suggests that the connector interface may be out of specification, for example due to wear or damage. Connectors on calibration and verification devices should also be gaged whenever they have been used by someone else or on another system or piece of equipment.

Precision 3.5mm and SMA connectors should be gaged relatively more often than other connectors, owing to the ease with which the center pins can be pulled out of specification during disconnection.

Connectors should also be gaged as a matter of routine - after every 100 connections and disconnections initially, more or less often after that as experience suggests.

Table G-1 Recommended connector gages

Connector gage kits containing all of the items required are included in many Agilent calibration kits. They are also available separately. Part numbers are as follows.	
Type	Part Number/Ordering Information
Precision 7mm (APC-7)	85050-80012
Precision 3.5mm	11752D
Precision 2.4mm	11752E
Type-N	85054-60047

Mechanical Specifications

The critical dimension to be measured, regardless of connector type, is the position (generally, the recession or setback) of the center conductor relative to the outer conductor mating plane.

Mechanical specifications for connectors specify a maximum distance and a minimum distance that the center conductor can be positioned behind (or, in female Type-N connectors, in front of) the outer conductor mating plane. Nominal specifications for each connector type exist, but the allowable tolerances (and sometimes the dimensions themselves) differ from manufacturer to manufacturer and from device to device. Therefore, before gaging any connector, consult the mechanical specifications provided with the connector or the device itself.

Precision 7mm Connectors

In precision 7mm connectors, contact between the center conductors is made by spring-loaded contacts called collets. These protrude slightly in front of the outer conductor mating plane when the connectors are apart. When the connection is tightened, the collets are compressed into the same plane as the outer conductors.

For this reason, two mechanical specifications are generally given for precision 7mm connectors: the maximum recession of the center conductor behind the outer conductor mating plane with the center conductor collet removed; and a minimum and maximum allowable protrusion of the center conductor collet in front of the outer conductor mating plane with the collet in place.

The center conductor collet should also spring back immediately when pressed with a blunt plastic rod or with the rounded plastic handle of the collet removing tool. Never use a pencil or your finger for this purpose.

With the center conductor collet removed, no protrusion of the center conductor in front of the outer conductor mating plane is allowable, and sometimes a minimum recession is required. Consult the mechanical specifications provided with the connector or the device itself.

Sexed Connectors

In Type-N and precision 3.5mm connectors, the position of the center conductor in the male connector is defined as the position of the shoulder of the male contact pin - not the position of the tip. The male contact pin slides into the female contact fingers and electrical contact is made by the inside surfaces of the tip of the female contact fingers on the sides of the male contact pin.

50 Ohm Type-N Connectors

NOTE

No Type-N connector should ever be used when there is any possibility of interference between the shoulder of the male contact pin and the tip of the female contact fingers when the connectors are mated. In practice this means that no Type-N connector pair should be mated when the separation between the tip of the female contact fingers and the shoulder of the male contact pin could be less than zero when the connectors are mated. Gage Type-N connectors carefully to avoid damage.

Type-N connectors differ from other connector types in that the outer conductor mating plane is offset from the mating plane of the center conductors. The outer conductor sleeve in the male connector extends in front of the shoulder of the male contact pin. When the connection is made, this outer conductor sleeve fits into a recess in the female outer conductor behind the tip of the female contact fingers (Figure G-5).

Figure G-5 **Type-N connectors**

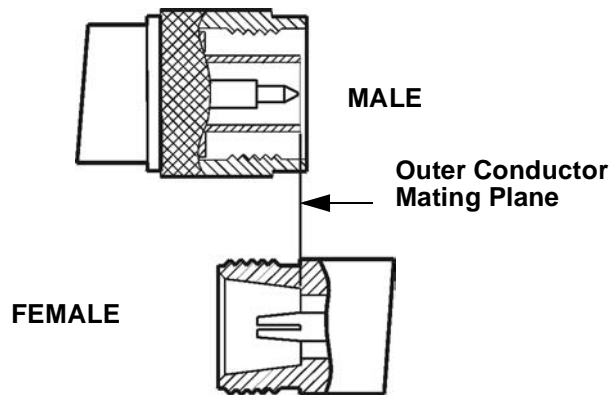

Therefore the mechanical specifications of Type-N connectors give a maximum protrusion of the female contact fingers in front of the outer conductor mating plane and a minimum recession of the shoulder of the male contact pin behind the outer conductor mating plane.

As Type-N connectors wear, the protrusion of the female contact fingers generally increases, due to wear of the outer conductor mating plane inside the female connector. This decreases the total center conductor contact separation and should be monitored carefully.

75 Ohm Type-N Connectors

75 Ω Type-N connectors differ from 50 Ω Type-N connectors most significantly in that the center conductor, male contact pin, and female contact hole are smaller. Therefore, mating a male 50 Ω Type-N connector with a female 75 Ω Type-N connector will destroy the female 75 Ω connector by spreading the female contact fingers apart permanently or even breaking them.

NOTE

If both 75 Ω and 50 Ω Type-N connectors are among those on the devices you are using, identify the 75 Ω Type-N connectors to be sure that they are never mated with any 50 Ω Type-N connectors.

Using Connector Gages

Before a connector gage is used, it must be inspected, cleaned, and zeroed.

Inspecting and Cleaning the Gage

Inspect the connector gage and the gage calibration block carefully, exactly as you have inspected the connector itself. Clean or replace the gage or the block if necessary (dirt on the gage or block will make the gage measurements of the connectors inaccurate and can transfer dirt to the connectors themselves, damaging them during gaging or when the connection is made).

Zeroing the Gage

Zero the gage by following the steps described below. Be sure that you are using the correct connector gage and correct end of the gage calibration block for the connector being measured.

- Hold the gage by the plunger barrel (not the dial housing or cap) and, for male connectors, slip the protruding end of the calibration block into the circular bushing on the connector gage. For precision 7mm, female precision 3.5mm use the flat end of the gage calibration block. For female Type-N connectors, use the recessed end of calibration block.
- Hold the gage by the plunger barrel only (Figure G-6). Doing so will prevent errors in gage readings due to the application of stresses to the gage plunger mechanism through the dial indicator housing.
- Carefully bring the gage and gage block together, applying only enough pressure to the gage and gage block to result in the dial indicator pointer settling at a reading.

Caring for Connectors
Using Connector Gages

- Gently rock the two surfaces together, to make sure that they have come together flatly. The gage pointer should now line up exactly with the zero mark on the gage. If it does not, inspect and clean the gage and gage calibration block again and repeat this process. If the gage pointer still does not line up with the zero mark on the gage, loosen the dial lock screw and turn the graduated dial until the gage pointer exactly lines up with zero. Then retighten the lock screw.

Figure G-6 **Using the connector gage**



NOTE

Gages should be checked often, to make sure that the zero setting has not changed. Generally, when the gage pointer on a gage that has been zeroed recently does not line up exactly with the zero mark, the gage or calibration block needs cleaning. Clean carefully and check the zero setting again.

Measuring Connectors

Measuring the recession of the center conductor behind the outer conductor mating plane in a connector is done in exactly the same way as zeroing the gage, except of course that the graduated dial is not re-set when the measurement is made.

If the connector has a retractable sleeve or sliding connector nut - precision 7mm connectors, for example - extend the sleeve or nut fully. This makes it easier to keep the gage centered in the connector.

Hold the gage by the plunger barrel and slip the gage into the connector so that the gage plunger rests against the center conductor. Carefully bring the gage into firm contact with the outer conductor mating plane.

Apply only enough pressure to the gage so that the gage pointer settles at a reading.

Gently rock the connector gage within the connector, to make sure that the gage and the outer conductor have come together flatly. Read the recession (or protrusion) from the gage dial. (For maximum accuracy, measure the connector several times and take an average of the readings.)

Rotate the gage relative to the connector between each measurement. To monitor connector wear, record the readings for each connector over time.

Making Connections

Making good connections is easy if a few simple principles are kept in mind:

- All connectors must be undamaged, clean, and within mechanical specification.
- The connectors must be precisely aligned with one another and in flat physical contact at all points on the mating plane surfaces.
- The connection must not be too tight or too loose.
- Lateral or horizontal (bending) force must not be applied to the connection, nor should any connection ever be twisted.

Align Connectors Carefully

Careful alignment of the connectors is critical in making a good connection, both to avoid damaging connectors and devices and to assure accurate measurements.

As you bring one connector up to the other and as you make the actual connection, be alert for any sign that the two connectors are not aligned perfectly. If you suspect that misalignment has occurred, stop and begin again.

Alignment is especially important in the case of sexed connectors, such as precision 3.5mm and SMA connectors, to avoid bending or breaking the contact pins. The center pin on the male connector must slip concentrically into the contact fingers of the female connector. This requires great care in aligning the two connectors before and as they are mated.

When they have been aligned, the center conductors must be pushed straight together, not twisted or screwed together, and only the connector nut (not the device itself) should then be rotated to make the connection. (slight resistance is generally felt as the center conductors mate).

Alignment of precision 7mm connectors is made easier by the fact that the connector sleeve on one of the connectors must be extended fully (and the sleeve on the other connector retracted fully) in order to make the connection. Extending the sleeve creates a cylinder into which the other connector fits.

If one of the connectors is fixed, as on a test port, extend that connector sleeve and spin its knurled connector nut to make sure that the threads are fully extended, while on the other connector, fully retract the connector sleeve.

To Make a Preliminary Connection

Align the two connectors carefully and engage the connector nut over the exposed connector sleeve threads on the other connector.

Gently turn the connector nut until a preliminary connection is made. Let the connector nut pull the two connectors straight together. Do not twist one connector body into the other (as you might drive a screw or insert a light bulb) as this is extremely harmful and can damage the connectors.

When the mating plane surfaces make uniform, light contact, the preliminary connection is tight enough. Do not overtighten this connection.

NOTE

At this stage all you want is a connection in which the outer conductors make gentle contact at all points on both mating surfaces. Very light finger pressure (no more than 2 inch-ounces of torque) is enough.

Final Connection Using a Torque Wrench

When the preliminary connection has been made, use a torque wrench to make the final connection. Tighten the connection only until the “break” point of the wrench is reached, when the wrench handle gives way at its internal pivot point. Do not tighten the connection further.

Also make sure that torque actually is being applied to the connection through the torque wrench, not only to the wrench handle or in any way that prevents the break point of the wrench from controlling the torque applied to the connection. Suggestions to ensure that torque is actually being applied are given in Table G-2 on page 155.

Using a torque wrench guarantees that the connection will not be too tight, thus preventing possible damage to the connectors and impaired electrical performance. It also guarantees that all connections will be made with the same degree of tightness every time they are made.

Torque wrenches pre-set to the correct value for each connector type are included in many Agilent calibration kits, and they are also available separately. Torque settings are detailed in Table G-2.

When using a torque wrench, prevent rotation of anything other than the connector nut that is being tightened with the torque wrench. Generally this is easy to do by hand (all the more so if one of the connectors is fixed) as on a test port. In other situations, an open-end wrench can be used to keep the bodies of the connectors from turning.

Hold the torque wrench lightly by the knurled end of the handle only. Apply force at the end of the torque wrench only, perpendicular to the wrench and always in a plane parallel to the outer conductor mating planes. This will result in torque being applied to the connection through the wrench until the break point of the wrench is reached.

Avoid pivoting the wrench handle on the thumb or other fingers. This results in an unknown amount of torque being applied to the connection when the break point of the wrench is reached. Avoid twisting the head of the wrench relative to the outer conductor mating plane. This results in applying more than the recommended torque.

Table G-2 Recommended Torque Settings

Type	Description
Precision 7mm	12 lb-in (136 N-cm.)
Precision 3.5mm	8 lb-in (90 N-cm)
SMA	5 lb-in (56 N-cm) Use the SMA wrench to connect male SMA connectors to female precision 3.5mm connectors. Connections of male precision 3.5mm. connectors to female SMA connectors can be made with the precision 3.5mm torque wrench (8 lb-in).
Type-N	Type-N connectors may be connected finger tight. If a torque wrench is used, 12 lb-in (136 N-cm) is recommended.

To reiterate the main do's and do not's detailed previously:

- Avoid holding the wrench tightly, in such a way that the handle is not pivoted but simply pushed downward the same amount throughout its length. If this is done, an unlimited amount of torque can be applied.
- Hold the wrench at the same point near the end of the handle every time, and always in the same orientation. Whenever possible, begin tightening the connection with the wrench held horizontally

Disconnection

Disconnect connectors by first loosening the connector nut that was tightened in order to make the connection. If necessary, use the torque wrench or an open-end wrench to start the process, but leave the connection finger tight. At all times support the devices and the connection to avoid putting lateral (bending) force on the connectors.

Complete the disconnection by disconnecting the connector nut completely.

NOTE

Never disconnect connectors by twisting one connector or device out of the other as one might remove a screw or a light bulb. This is extremely harmful and connector damage can occur whenever the device body rather than the nut alone is being turned.

If the connection is between sexed connectors, pull the connectors straight apart and be especially careful not to twist the body of any device as you do so. Twisting the connection can damage the connector by damaging the center conductors or the interior component parts to which the connectors themselves are attached. It can also scrape the plating from the male contact pin or even (in rare instances) unscrew the male or female contact pin slightly from its interior mounting, bringing it out of specification (this can also occur if the female contact fingers are unusually tight).

Adapters

Adapters are used to connect a device with one connector interface to a device or to test equipment that has another interface, or to reduce wear on connectors that may be difficult or expensive to replace. Reducing wear is possibly the most important use of adapters, especially when devices that have SMA connectors are being used.

SMA connectors are low-cost connectors generally used up to about 23GHz. They are not precision mechanical devices and are not designed for repeated connections and disconnections as they wear out quickly and are very often found, upon assembly, to be out of specification, even before they have been used. This makes them potentially destructive to any precision 3.5mm connectors with which they might be mated.

CAUTION

Worn, damaged, or out-of-specification SMA connectors can destroy a precision 3.5mm connector even on the very first connection. For this reason it is recommended that you use high-quality precision adapters, sometimes called “connector savers”, whenever more than a few connections are to be made between SMA and precision 3.5mm connectors.

In most applications two adapters will be required, one each at the input and the output of the device. Male-female adapters cause no change in the sex of the interface. The same interface is presented when the adapter is in place as is presented in the original setup.

Same-sex adapters (male-male, female-female) change the sex of the interface. For example, if the original interface presents a male connector, attaching a female-female adapter will result in a female interface to which devices or cables that have male SMA (or male precision 3.5mm) connectors can be connected.

Adapters are included in many Agilent calibration kits and with many Agilent devices, or they may be ordered separately.

Caring for Connectors
Adapters

Table G-3 Adapters

Type	Description
Precision 7mm and Type-N	Precision 7mm/male 3.5mm Precision 7mm/female 3.5 mm Precision 7mm/male 50Ω Type-N Precision 7mm/female 50Ω Type-N
Precision 3.5mm and SMA	Male 3.5mm/female 3.5mm Male 3.5mm/female 3.5 mm Female 3.5mm/female 3.5mm Precision 7mm/male 3.5mm Precision 7mm/female 3.5mm “Connector saver” male 3.5mm/female 3.5 mm “Connector saver” male 3.5mm/male 3.5mm

Principles of Microwave Connector Care

Table G-4 Principles of Microwave Connector Care

Handling and Storage	
DO	DO NOT
<ul style="list-style-type: none"> • Keep connectors clean. • Extend sleeve or connector nut. • Use plastic end caps during storage. 	<ul style="list-style-type: none"> • Touch mating plane surfaces. • Set connectors contact-end down.
Visual Inspection	
DO	DO NOT
<ul style="list-style-type: none"> • Inspect each connector carefully before every connection. • Look for metal particles, scratches and dents. 	<ul style="list-style-type: none"> • Use a damaged connector - EVER.
Cleaning	
DO	DO NOT
<ul style="list-style-type: none"> • Try compressed air first. • Clean connector threads. 	<ul style="list-style-type: none"> • Use any abrasives. • Get liquid onto plastic support beads.

Caring for Connectors
Principles of Microwave Connector Care

Table G-4 Principles of Microwave Connector Care

Gaging	
DO	DO NOT
<ul style="list-style-type: none"> • Clean and zero the gage before using. • Use correct gage type. • Use correct end of calibration block. • Gage all connectors before first use. 	<ul style="list-style-type: none"> • Use an out-of-spec connector.
Making Connections	
DO	DO NOT
<ul style="list-style-type: none"> • Align connectors carefully. • Make preliminary connection lightly. • Turn connector nut only to tighten. • Use a torque wrench for final connection. 	<ul style="list-style-type: none"> • Apply bending force to connection. • Overtighten preliminary connection. • Twist or screw in connectors. • Tighten past “break” point of torque wrench.